





120

Wand/Deckenleuchte Jade



89

COB Glasdownlight

## INHALT

6-23	Allgemeine Informationen
24-31	LED Einbaupanel round / Clip on
32-65	LED Panel: Easy fix, LED Panel
66-69	LED Ein- Unterbauleuchte
70-85	LED Shopbeleuchtung
86-119	LED Downlight und Einbaustrahler
120-139	LED Wand- und Deckenleuchte
140-149	LED Feuchtraumleuchten
150-151	LED Hallenleuchte
152-159	LED Außenbeleuchtung
160-173	LED Flutlichtstrahler
174-175	LED Unterbauleuchte
176-185	Zubehör für LED Strahler und Downlight

186-201	LED Fadenlampen / dimmbar
202-215	LED Fadenlampen / nicht dimmbar
216-231	LED Lampen / dimmbar
232-253	LED Lampen / nicht dimmbar
254-263	LED 12 V / 230 V / nicht dimmbar
264-269	LED Lampen GX53 / G9
270-275	LED Röhren
276-295	Halogen-Ecolampen
296-301	Energie-Sparlampen
302-329	Kompakt-Leuchtstofflampen
330-333	Halogen-Lampen
334-337	Glühlampen
338-343	Zubehör
344-369	Ausverkauf
370-375	Allgemeine Informationen
376-383	Artikelnummerverzeichnis



77

LED Schienenstrahler Spot



94

LED Einbauspot IP65



46

LED Panel Butterfly

# NEUHE

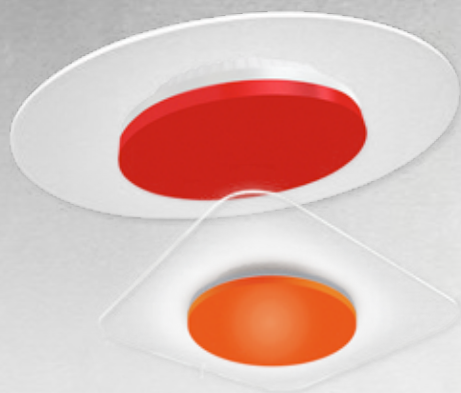

## WAND / DECKENLEUCHE JADE

Der Microdruck im Acrylglasring (PMMA)  
setzt attraktive Lichteffekte

Mittenabdeckung austauschbar

Optionale Farben für Mittenabdeckung



## LED COB GLASDOWNLIGHT

hohe Farbwiedergabe  $Ra > 80$

inkl. Treiber (extern)

Gehäuse: Aluminium

Optik: gehärtetes Glas

Zierring: PC



## EINBAULEUCHE SANDWICH

hohe Farbwiedergabe  $R_a > 80$

inkl. Treiber (extern)

nicht dimmbar

Gehäuse: Aluminium

Optik: PMMA



## LED AUßENWANDLEUCHE CUBE

inkl. Treiber, nicht dimmbar

Aluminiumgehäuse

hohe Farbwiedergabe  $R_a > 80$



## AUFBAU eines LED PANEL

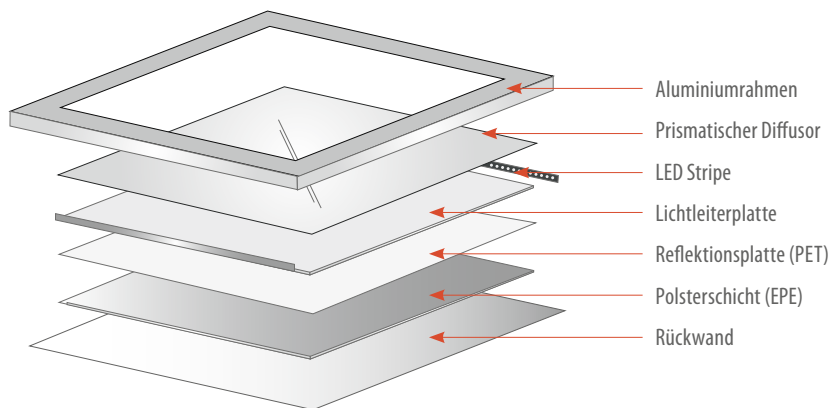





### OPTIONALE DIMMTREIBER

Artikelnummer	Bezeichnung	Dimmart	Seite
81-9018	ML50-PDV	1-10 V, Push, Dali	179
81-9012	XZ-CI/4513	1-10 V	183

### RAHMEN / MONTAGEZUBEHÖR

81-2101	Seilabhängig	Set = 4 Seile	54
81-1100	Einbaurahmen	weiß / 630 x 630 mm	54
81-1004	Anbaurahmen, offen	weiß / 622 x 622 mm	54
81-1009	Anbaurahmen, geschlossen	weiß / steckbar, schraubenlos / 625 x 625 mm	55
81-1101	Einbaurahmen	weiß / 1.200 x 300 mm	55
81-1102	Anbaurahmen, geschlossen	weiß / 1.200 x 300 mm	55
81-1008	Anbaurahmen, geschlossen	weiß / steckbar, schraubenlos / 300 x 300 mm	55
81-1007	Klemmfedern	für Snap In Montage / Set = 4 Stück	54

	LED PANEL UGR <19	LED HIGH-LUMEN PANEL	LED PANEL	LED PANEL
				
	81-2040 81-2041 81-2042	81-2043 81-2044 81-2045	81-2046 81-2047 81-2048 81-2049	81-2060 81-2061
	✓	✓	✓	✓
	✓	✓	✓	
	1 Set	1 Set	2 Set	✗
	✓	✓	✗	✗
	✓	✓	✗	✗
	✓	✓	✗	✗
	✗	✗	✓	✗
	✗	✗	✓	✗
	✗	✗	✗	✓
	1 Set	1 Set	2 Set	✗



**CLIP ON**

**tion von LED Einbau Panel**

# LED EIN-/ UNTERBAUPANEL / CLIP ON MAGNET inkl. Treiber



## Befestigung einstellbar auf verschiedene, bereits bestehende Deckenausschnitte

6W	55–90 mm	18W	55–175 mm
12W	55–125 mm	24W	60-250 mm



Dekorring

Art.-Nr.	Bezeichnung
89-2020	Dekorring eisen-gebürstet 140 mm für 6 W Clip on
89-2021	Dekorring eisen-gebürstet 165 mm für 12 W Clip on
89-2022	Dekorring eisen-gebürstet 219 mm für 18 W Clip on
89-2023	Dekorring eisen-gebürstet 293 mm für 24 W Clip on

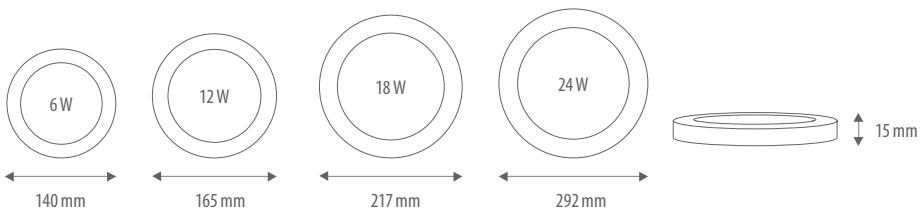



### Lieferbar ab Oktober 2018

Artikelnummer	Leistung	Spannung	Lichtfarbe	Farbtemperatur	mittlere Lebensdauer	Lichtstrom	Abstrahlwinkel	Energieeffizienz	Durchmesser mm	Höhe mm	Deckenausschnitt mm
81-4030	6 W	230 V	warmweiß	3.000 K	30.000 h	400 lm	120°	A <sup>+</sup>	140	15	55-90
81-4031	12 W	230 V	warmweiß	3.000 K	30.000 h	1.000 lm	120°	A <sup>+</sup>	165	15	55-125
81-4032	18 W	230 V	warmweiß	3.000 K	30.000 h	1.550 lm	120°	A <sup>+</sup>	217	15	55-175
81-4033	24 W	230 V	warmweiß	3.000 K	30.000 h	2.200 lm	120°	A <sup>+</sup>	292	15	60-250
81-4034	6 W	230 V	weiß	4.000 K	30.000 h	420 lm	120°	A <sup>+</sup>	140	15	55-90
81-4035	12 W	230 V	weiß	4.000 K	30.000 h	1.100 lm	120°	A <sup>+</sup>	165	15	55-125
81-4036	18 W	230 V	weiß	4.000 K	30.000 h	1.600 lm	120°	A <sup>+</sup>	217	15	55-175
81-4037	24 W	230 V	weiß	4.000 K	30.000 h	2.300 lm	120°	A <sup>+</sup>	292	15	60-250

- Leuchte mit integriertem DIM (Triac) Treiber / Phasenabschnitt
- Leuchte mit Magneten zur Befestigung des Dekorringes
- Passende Dekorringe: 89-2020 (6 W), 89-2021 (12 W), 89-2022 (18 W), 89-2023 (24 W)
- Gehäusefarbe: weiß



Diese Leuchte enthält eingebaute LED. Diese LED können in der Leuchte nicht ausgetauscht werden.



# LED EIN-/ UNTERBAUPANEL / CLIP ON inkl. Treiber



## Befestigung einstellbar auf verschiedene, bereits bestehende Deckenausschnitte

6W	55–80 mm	18W	60–185 mm
12W	60–135 mm	24W	60–260 mm

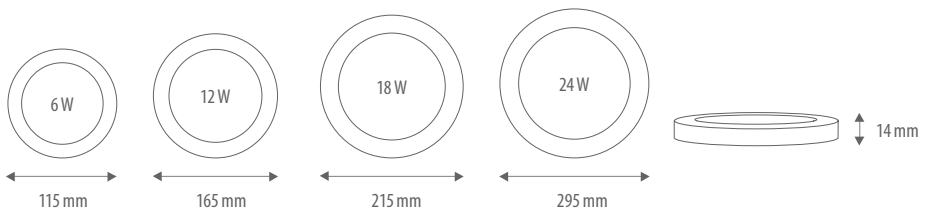

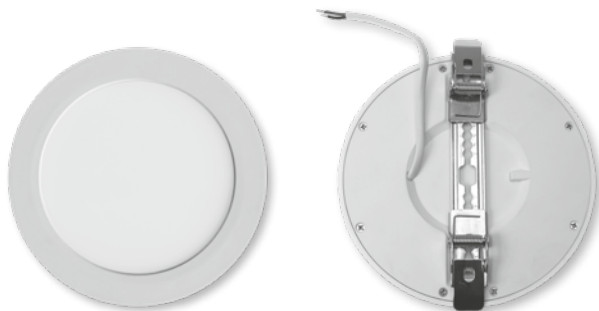

Artikelnummer	Leistung	Spannung	Lichtfarbe	Farbtemperatur	mittlere Lebensdauer	Lichtstrom	Abstrahlwinkel	Energieeffizienz	Durchmesser mm	Höhe mm	Deckenausschnitt mm
81-4018	6 W	230 V	warmweiß	3.000 K	30.000 h	400 lm	120°	A+	115	14	55–80
81-4019	12 W	230 V	warmweiß	3.000 K	30.000 h	1.000 lm	120°	A+	165	14	60–135
81-4020	18 W	230 V	warmweiß	3.000 K	30.000 h	1.550 lm	120°	A+	215	14	60–185
81-4021	24 W	230 V	warmweiß	3.000 K	30.000 h	2.200 lm	120°	A+	295	14	60–260
81-4026	6 W	230 V	weiß	4.000 K	30.000 h	420 lm	120°	A+	115	14	55–90
81-4027	12 W	230 V	weiß	4.000 K	30.000 h	1.100 lm	120°	A+	165	14	60–135
81-4024	18 W	230 V	weiß	4.000 K	30.000 h	1.600 lm	120°	A+	215	14	60–185
81-4025	24 W	230 V	weiß	4.000 K	30.000 h	2.300 lm	120°	A+	295	14	60–260

- Leuchte mit integriertem DIM (TRIAC) Treiber / Phasenabschnitt
- Gehäusefarbe: weiß



Diese Leuchte enthält eingebaute LED. Diese LED können in der Leuchte nicht ausgetauscht werden.





# LED PANEL

Neue Generation v



# EASY FIX

von LED Panel



# LED PANEL Easy Fix / UGR < 19 inkl. treiber

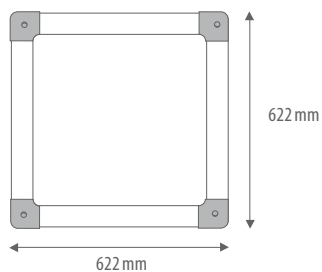
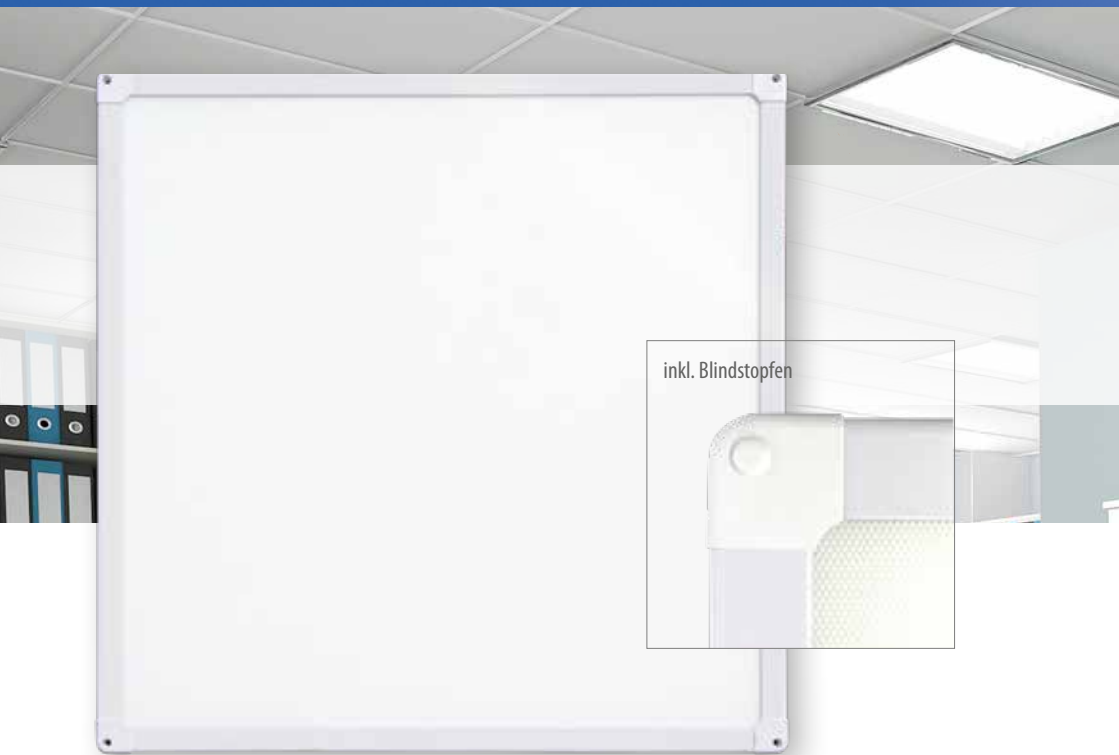

Diese Leuchte enthält eingebaute LED. Diese LED können in der Leuchte nicht ausgetauscht werden.

# JETZT BEI UNS!

## EASY FIX PANELSYSTEM

Artikelnummer	Leistung	Spannung	Lichtfarbe	Farbtemperatur	mittlere Lebensdauer	Lichtstrom	Ausgangs-Strom	Abstrahlwinkel	Energieeffizienz	Maße L x B mm	Höhe mm
81-2073	40W	230V	warmweiß	3.000 K	50.000 h	4.000 lm	900 mA	90°	A+	622 x 622	23
81-2074	40W	230V	weiß	4.000 K	50.000 h	4.200 lm	900 mA	90°	A+	622 x 622	23

- Leuchte mit Treiber (extern)
- Bildschirmarbeitsplatz tauglich
- Material: Aluminiumgehäuse
- Rahmenfarbe: weiß



# LED LONG PANEL Easy Fix UGR <19 inkl. Treiber

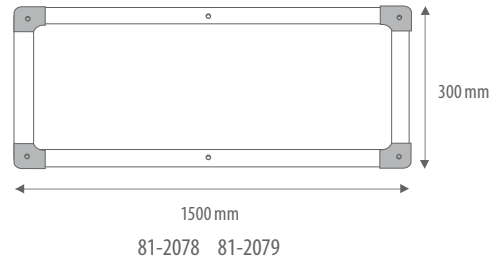
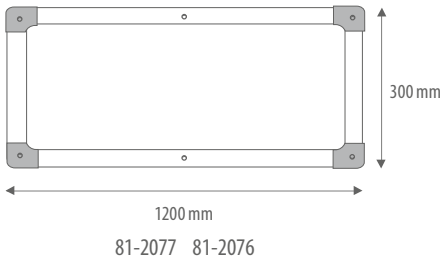

Diese Leuchte enthält eingebaute LED. Diese LED können in der Leuchte nicht ausgetauscht werden.



# JETZT BEI UNS!

## EASY FIX PANELSYSTEM

Artikelnummer	Leistung	Spannung	Lichtfarbe	Farbtemperatur	mittlere Lebensdauer	Lichtstrom	Ausgangs-Strom	Abstrahlwinkel	Energieeffizienz	Länge mm	Breite mm	Höhe mm
81-2076	40 W	230 V	warmweiß	3.000 K	50.000 h	4.000 lm	900 mA	90°	A+	1200	300	23
81-2077	40 W	230 V	weiß	4.000 K	50.000 h	4.000 lm	900 mA	90°	A+	1200	300	23
81-2079	40 W	230 V	warmweiß	3.000 K	50.000 h	4.900 lm	950 mA	90°	A+	1500	300	23
81-2078	40 W	230 V	weiß	4.000 K	50.000 h	4.900 lm	950 mA	90°	A+	1500	300	23

- Leuchte mit Treiber (extern)
- zum Anschluß an 230 V Netzspannung
- Material: Aluminiumgehäuse
- Rahmenfarbe: weiß
- Bildschirmarbeitsplatz tauglich



# LED PANEL Easy Fix inkl. Treiber

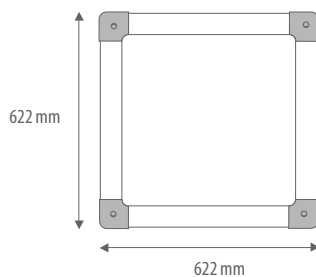
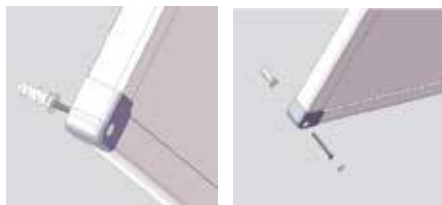
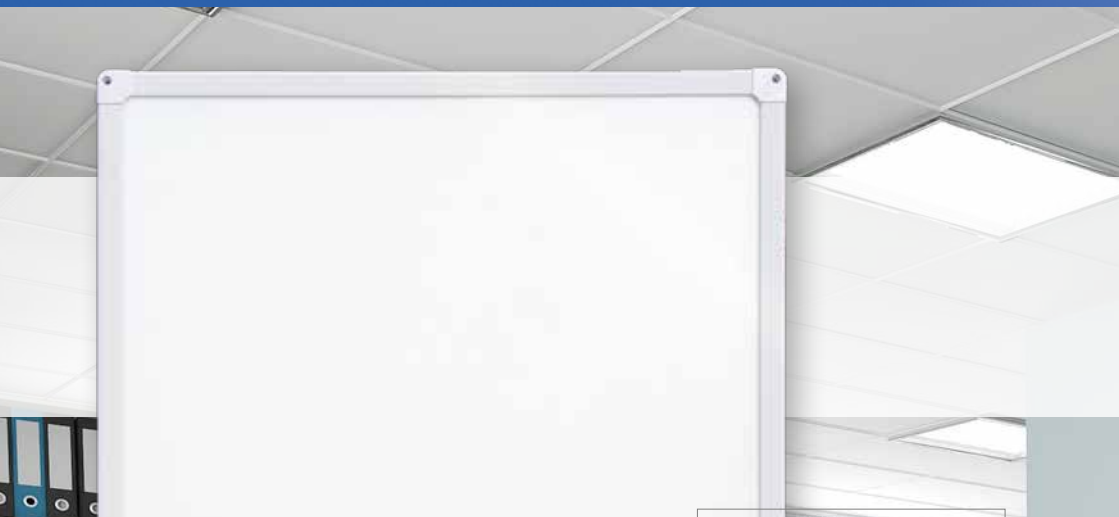

Diese Leuchte enthält eingebaute LED. Diese LED können in der Leuchte nicht ausgetauscht werden.

# JETZT BEI UNS! EASY FIX PANELSYSTEM

Artikelnummer	Leistung	Spannung	Lichtfarbe	Farbtemperatur	mittlere Lebensdauer	Lichtstrom	Ausgangs-Strom	Abstrahlwinkel	Energieeffizienz	Maße L x B mm	Höhe mm
81-2070	40W	230 V	warmweiß	3.000 K	50.000 h	4.200 lm	900 mA	120°	A+	622 x 622	23
81-2071	40W	230 V	weiß	4.000 K	50.000 h	4.400 lm	900 mA	120°	A+	622 x 622	23

- Leuchte mit Treiber (extern)
- Material: Aluminiumgehäuse
- Rahmenfarbe: weiß
- zum Anschluß an 230 V Netzspannung





# LED PANEL UGR < 19 inkl. Treiber



optional dimmbar mit LED Konverter Art.Nummer:

81-9012, 81-9018

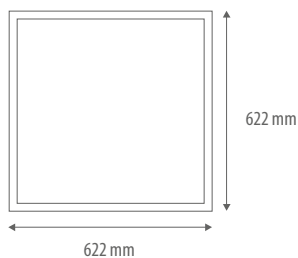

Diese Leuchte enthält eingebaute LED. Diese LED können in der Leuchte nicht ausgetauscht werden.



Artikelnummer	Leistung	Spannung	Lichtfarbe	Farbtemperatur	mittlere Lebensdauer	Lichtstrom	Ausgangs-Strom	Abstrahlwinkel	Energieeffizienz	Maße L x B	Höhe mm
81-2040	40W	230 V	warmweiß	3.000 K	50.000 h	3.700 lm	700 mA	90°	A+	622 x 622	11
81-2041	40W	230 V	weiß	4.000 K	50.000 h	4.100 lm	700 mA	90°	A+	622 x 622	11
81-2042	40W	230 V	kaltweiß	6.000 K	50.000 h	4.100 lm	700 mA	90°	A+	622 x 622	11

- Leuchte mit Treiber (extern)
- UGR < 19
- Bildschirmarbeitsplatz tauglich
- zum Anschluß an 230 V Netzspannung
- Material: Aluminiumgehäuse
- Rahmenfarbe: weiß
- Schutzart IP 20
- bis 100 lm / W



# LED PANEL 600 UGR < 19



optional dimmbar mit LED Konverter Art.Nummer:

81-9012, 81-9018

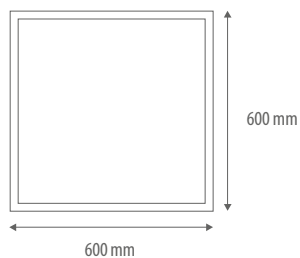

Diese Leuchte enthält eingebaute LED. Diese LED können in der Leuchte nicht ausgetauscht werden.



Artikelnummer	Leistung	Spannung	Lichtfarbe	Farbtemperatur	mittlere Lebensdauer	Lichtstrom	Ausgangs-Strom	Abstrahlwinkel	Energieeffizienz	Maße L x B	Höhe mm
81-2082	40W	230 V	warmweiß	3.000 K	50.000 h	3.720 lm	1.050 mA	90°	A+	600 x 600	11
81-2083	40W	230 V	weiß	4.000 K	50.000 h	4.000 lm	1.050 mA	90°	A+	600 x 600	11

- Leuchte mit Treiber (extern)
- UGR < 19
- Bildschirmarbeitsplatz tauglich
- zum Anschluß an 230V Netzspannung
- Material: Aluminiumgehäuse
- Rahmenfarbe: weiß
- Schutzart IP 20
- bis 100 lm / W



# LED LONG PANEL UGR <19 inkl. Treiber



optional dimmbar mit LED Konverter Art.Nummer:  
81-9012 / 81-9018



Diese Leuchte enthält eingebaute LED. Diese LED können in der Leuchte nicht ausgetauscht werden.



Artikelnummer	Leistung	Spannung	Lichtfarbe	Farbtemperatur	mittlere Lebensdauer	Lichtstrom	Ausgangs-Strom	Abstrahlwinkel	Energieeffizienz	Länge mm	Breite mm	Höhe mm
81-2048	36 W	230 V	weiß	4.000 K	50.000 h	3.500 lm	700 mA	90°	A+	1.200	300	11
81-2049	36 W	230 V	warmweiß	3.000 K	50.000 h	3.100 lm	700 mA	90°	A+	1.200	300	11

- Leuchte mit Treiber (extern)
- Material: Aluminiumgehäuse
- Schutzart IP 20
- Rahmenfarbe: weiß
- Bildschirmarbeitsplatz tauglich



# LED PANEL BUTTERFLY UGR <19 inkl. Treiber



optional dimmbar mit LED Konverter Art.Nr.: 81-9018

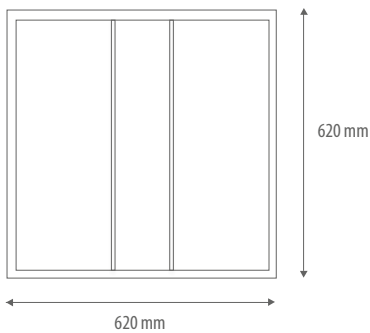

Diese Leuchte enthält eingebaute LED. Diese LED können in der Leuchte nicht ausgetauscht werden.

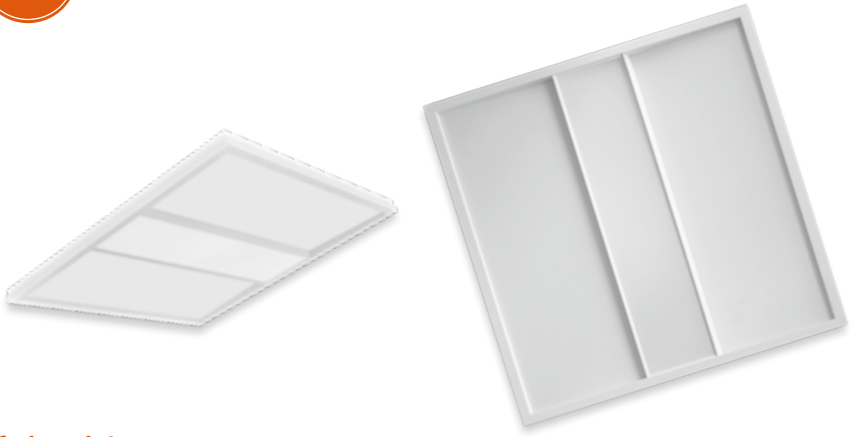

Lieferbar ab Januar 2019

Artikelnummer	Leistung	Spannung	Lichtfarbe	Farbtemperatur	mittlere Lebensdauer	Lichtstrom	Ausgangs-Strom	Abstrahlwinkel	Energieeffizienz	Länge mm	Breite mm	Höhe mm
81-2050	40 W	230 V	weiß	4.000 K	50.000 h	4.000 lm	1.050 mA	90°	A+	620	620	30

- Leuchte mit Treiber (extern)
- Material Rahmen: Aluminium
- Rahmenfarbe: weiß
- Schutzart IP 20
- Bildschirmarbeitsplatz tauglich
- zum Anschluß an 230V





# LED HIGH-LUMEN PANEL inkl. Treiber



optional dimmbar mit LED Konverter Art.Nummer:  
81-9012, 81-9018

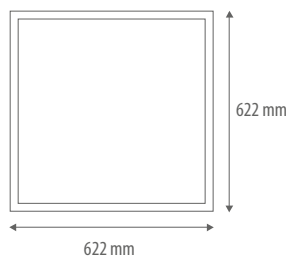

Diese Leuchte enthält eingebaute LED. Diese LED können in der Leuchte nicht ausgetauscht werden.



Artikelnummer	Leistung	Spannung	Lichtfarbe	Farbtemperatur	mittlere Lebensdauer	Lichtstrom	Ausgangs-Strom	Abstrahlwinkel	Energieeffizienz	Maße L x B	Höhe mm
81-2043	40 W	230 V	warmweiß	3.000 K	50.000 h	4.000 lm	700 mA	120°	A+	622 x 622	12
81-2044	40 W	230 V	weiß	4.000 K	50.000 h	4.300 lm	700 mA	120°	A+	622 x 622	12
81-2045	40 W	230 V	kaltweiß	6.000 K	50.000 h	4.500 lm	700 mA	120°	A+	622 x 622	12

- Leuchte mit Treiber (extern)
- Material: Aluminiumgehäuse
- Rahmenfarbe: weiß
- Schutzart IP 20
- zum Anschluß an 230V Netzspannung
- bis 112 lm /W



# LED LONG PANEL inkl. Treiber



optional dimmbar mit LED Konverter Art.Nummer:  
81-9012/81-9018

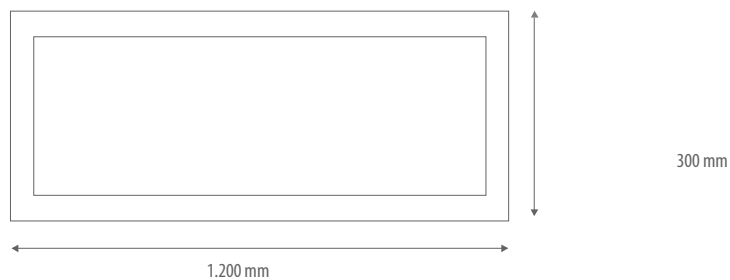

Diese Leuchte enthält eingebaute LED. Diese LED können in der Leuchte nicht ausgetauscht werden.



Artikelnummer	Leistung	Spannung	Lichtfarbe	Farbtemperatur	mittlere Lebensdauer	Lichtstrom	Ausgangs-Strom	Abstrahlwinkel	Energieeffizienz	Länge mm	Breite mm	Höhe mm
81-2046	36 W	230 V	weiß	4.000 K	50.000 h	3.680 lm	700 mA	120°	A+	1.200	300	11
81-2047	36 W	230 V	warmweiß	3.000 K	50.000 h	3.200 lm	700 mA	120°	A+	1.200	300	11

- Leuchte mit Treiber (extern)
- Material: Aluminiumgehäuse
- Rahmenfarbe: weiß
- Schutzart IP 20



# LED PANEL 300 inkl. Treiber



279 mm – 279 mm

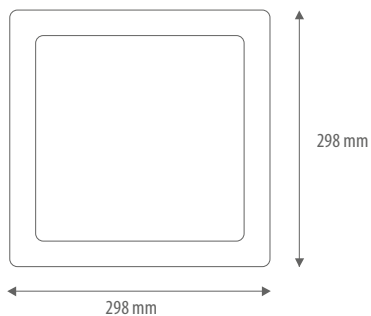

Passendes Zubehör: Unterbaurahmen: 81-1008

Diese Leuchte enthält eingebaute LED. Diese LED können in der Leuchte nicht ausgetauscht werden.



Artikelnummer	Leistung	Spannung	Lichtfarbe	Farbtemperatur	mittlere Lebensdauer	Lichtstrom	Abstrahlwinkel	Energieeffizienz	Maße L x B	Höhe mm
81-2066	24W	230V	warmweiß	3.000 K	30.000 h	1.920 lm	120°	A+	298 x 298	30
81-2067	24W	230V	weiß	4.000 K	30.000 h	2.100 lm	120°	A+	298 x 298	30

- Leuchte mit integriertem dim. Treiber (TRIAC) / Phasenabschnitt
- Material: Kunststoff
- Snap-In oder Aufbaumontage (Aufbau mit Rahmen 81-1008)



# LED PANEL MONTAGEZUBEHÖR

**Artikelnummer: 81-2101**

**Seilabhängung Komplett-Set für LED-Panel:**

81-2040, 81-2041, 81-2042, 81-2043, 81-2044, 81-2045, 81-2046, 81-2047, 81-2048

Diese Seilabhängung ist zur Nutzung mit allen oben gelisteten LED-Panel geeignet. Mit dieser Aufhängung können Sie die LED-Panel als dekorative LED-Pendelleuchte nutzen.

**1 Komplett-Set enthält:**

- 4 Seile á 1,5 m, 4 x Deckenbefestigung
- 4 x Verschraubungen am LED-Panel  
für LED-Panels ab 1200 mm benötigen Sie 2 Sets  
für LED-Panel 622 x 622 mm benötigen Sie 1 Set



**Artikelnummer: 81-1100 / Einbaurahmen / weiß**

Dieses Panel Einbaurahmen-Set ermöglicht den einfachen und komfortablen Decken-Einbau Ihres LED-Panels mit den Maßen 622 x 622 mm. Optimal geeignet für den Einbau in abgehängte Gipskartondecken. Der Einbaurahmen wird als Montagesatz geliefert. Farbe: weiß  
Einbautiefe: 40 mm

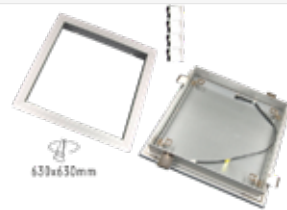

**Artikelnummer: 81-1004 / Unterbaurahmen / weiß**

Mit diesem Unterbaurahmen für die 622 x 622 mm LED-Panel ist es möglich, das LED-Panel auf einfache Weise als LED-Anbauleuchte zu montieren.

Der Unterbaurahmen wird direkt auf die Rückseite des LED-Panel geschraubt und erzeugt dadurch eine Schattenfuge. Farbe: weiß

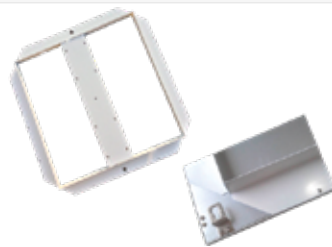

**Artikelnummer: 81-1007/ Federn**

Für „Snap In“-Montage der 622 x 622 mm und 1.200 x 300 mm Panel.  
für LED-Panels ab 1200 mm benötigen Sie 2 Sets  
für LED-Panel 622 x 622 mm benötigen Sie 1 Set  
Deckenausschnitt für 622 x 622 mm: 580 x 580 mm  
Deckenausschnitt für 1.200 x 300 mm: 1.150 x 250 mm



**Artikelnummer: 81-1008 / Unterbaurahmen / weiß**

Mit diesem Unterbaurahmen für die 300 x 300 mm LED-Panel ist es möglich, das LED-Panel auf einfache Weise als LED-Anbauleuchte zu montieren.

Der Unterbaurahmen ist umläufig geschlossen.  
Höhe: 42 mm



**Artikelnummer: 81-1009 / Unterbaurahmen / weiß**

Mit diesem Unterbaurahmen für die 622 x 622 mm LED-Panel ist es möglich, das jeweils LED-Panel auf einfache Weise als LED-Anbauleuchte zu montieren.

Der Unterbaurahmen ist umläufig geschlossen.  
Höhe: 42 mm

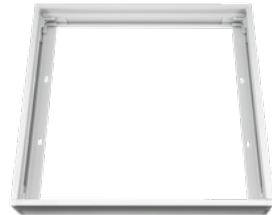

**Artikelnummer: 81-1101 / Einbaurahmen / weiß**

Dieses Panel Einbaurahmen-Set ermöglicht den einfachen und komfortablen Decken-Einbau Ihres LED-Panels mit den Maßen 1200 x 300 mm. Optimal geeignet für den Einbau in abgehängte Gipskartondecken. Der Einbaurahmen wird als Montagesatz geliefert.

Außenmaß: 1240 mm x 340 mm

Lochmaß: 1205 mm x 305 mm

Farbe: weiß

Einbautiefe: 40 mm



**Artikelnummer: 81-1102 / Unterbaurahmen / weiß**

Mit diesem Unterbaurahmen 1200 x 300 mm für das LED-Panel 81-2046, 81-2047, 81-2048, 81-2049 ist es möglich, das LED-Panel auf einfache Weise als LED-Anbauleuchte zu montieren.

Farbe: weiß

Höhe: 50 mm

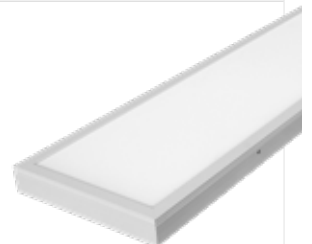

Bauliche Veränderungen vorbehalten.



# LED PANEL EINBAU inkl. Treiber

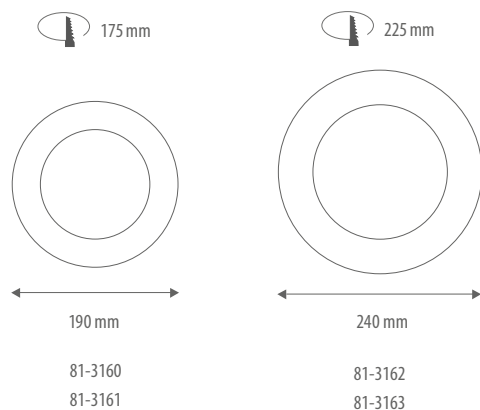

Diese Leuchte enthält eingebaute LED. Diese LED können in der Leuchte nicht ausgetauscht werden.



Artikelnummer	Leistung	Spannung	Lichtfarbe	Farbtemperatur	mittlere Lebensdauer	Lichtstrom	Ausgangs-Strom	Abstrahlwinkel	Energieeffizienz	Durchmesser mm	Höhe mm
81-3160	16 W	230 V	warmweiß	3.000 K	40.000 h	1.000 lm	300 mA	110°	A <sup>+</sup>	190	14
81-3161	16 W	230 V	weiß	4.000 K	40.000 h	1.070 lm	300 mA	110°	A <sup>+</sup>	190	14
81-3162	26 W	230 V	warmweiß	3.000 K	40.000 h	1.950 lm	600 mA	110°	A <sup>+</sup>	240	14
81-3163	26 W	230 V	weiß	4.000 K	40.000 h	2.020 lm	600 mA	110°	A <sup>+</sup>	240	14

- inkl. Treiber (extern)
- LED-Leuchte für Netzspannung 230 V
- Außenringfarbe: weiß



# LED UP-DOWN PANEL UGR<19 inkl. Treiber



optional dimmbar mit LED Konverter Art.Nummer: 81-9018

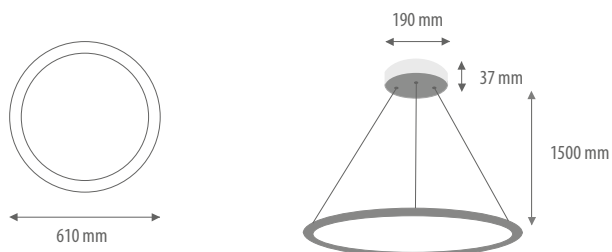

Diese Leuchte enthält eingebaute LED. Diese LED können in der Leuchte nicht ausgetauscht werden.



## Lieferbar ab Januar 2019

Artikelnummer	Leistung	Spannung	Lichtfarbe	Farbtemperatur	mittlere Lebensdauer	Lichtstrom	Ausgangs-Strom	Abstrahlwinkel	Energieeffizienz	Durchmesser mm	Höhe mm
81-2080	50 W	230 V	warmweiß	3.000 K	50.000 h	4.930 lm	1.050 mA	90°	A+	610	11
81-2081	50 W	230 V	weiß	4.000 K	50.000 h	5.300 lm	1.050 mA	90°	A+	610	11

- Leuchte mit Treiber im Baldachin
- Aluminiumgehäuse
- Rahmenfarbe: weiß
- Schutzart IP 20
- inkl. Abhängeset



# LED UP-DOWN PANEL inkl. Treiber



optional dimmbar mit LED Konverter, Art.Nummer: 81-9018

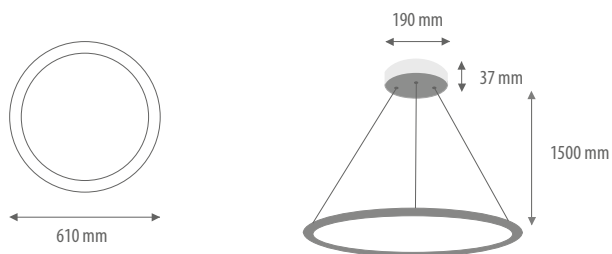

Diese Leuchte enthält eingebaute LED. Diese LED können in der Leuchte nicht ausgetauscht werden.



Artikelnummer	Leistung	Spannung	Lichtfarbe	Farbtemperatur	mittlere Lebensdauer	Lichtstrom	Ausgangs-Strom	Abstrahlwinkel	Energieeffizienz	Durchmesser mm	Höhe mm
81-2064	48 W	230 V	warmweiß	3.000 K	40.000 h	4.450 lm	1.050 mA	110°	A+	610	11
81-2065	48 W	230 V	weiß	4.000 K	40.000 h	4.800 lm	1.050 mA	110°	A+	610	11

- Leuchte mit Treiber im Baldachin
- Aluminiumgehäuse
- Rahmenfarbe: weiß
- Schutzart IP 20
- inkl. Abhängeset



# LED UP-DOWN PANEL UGR <19 inkl. Treiber



## Deckenbaldachin

Länge: 240 x 70 mm  
Höhe: 40 mm

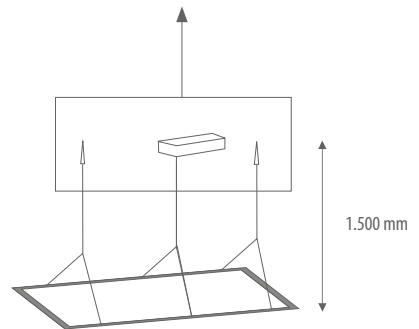
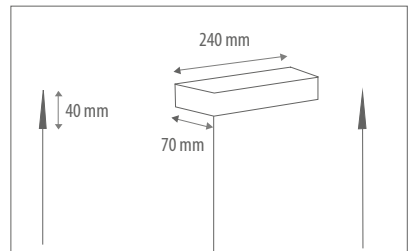
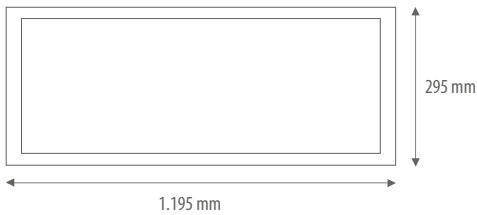

Diese Leuchte enthält eingebaute LED. Diese LED können in der Leuchte nicht ausgetauscht werden.

30 % uplight

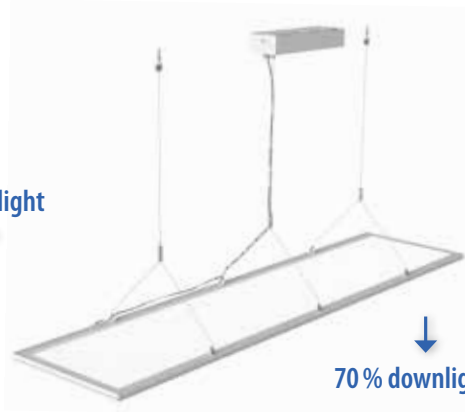

70 % downlight

Lieferbar ab Januar 2019

Artikelnummer	Leistung	Spannung	Lichtfarbe	Farbtemperatur	mittlere Lebensdauer	Lichtstrom	Ausgangs-Strom	Abstrahlwinkel	Energieeffizienz	Maße L x B mm	Höhe mm
81-2068	40 W	230 V	warmweiß	3.000 K	50.000 h	3.720 lm	700 mA	90°	A+	295 x 1195	11
81-2069	40 W	230 V	weiß	4.000 K	50.000 h	4.000 lm	700 mA	90°	A+	295 x 1195	11

optional dimmbar mit LED Konverter Art.Nummer: 81-9012

- hohe Farbwiedergabe Ra > 80
- inkl. Treiber (im Baldachin)
- Aluminiumgehäuse
- Rahmenfarbe: weiß
- inkl. Abhängeset





# LED UP-DOWN PANEL inkl. Treiber



## Deckenbaldachin



Länge: 240 x 70 mm  
Höhe: 40 mm

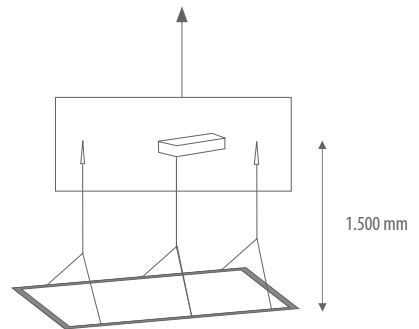
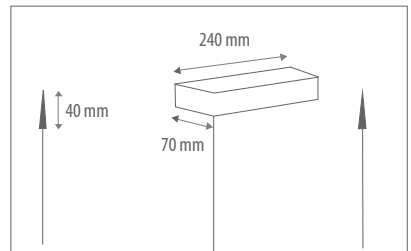

Diese Leuchte enthält eingebaute LED. Diese LED können in der Leuchte nicht ausgetauscht werden.

30 % uplight

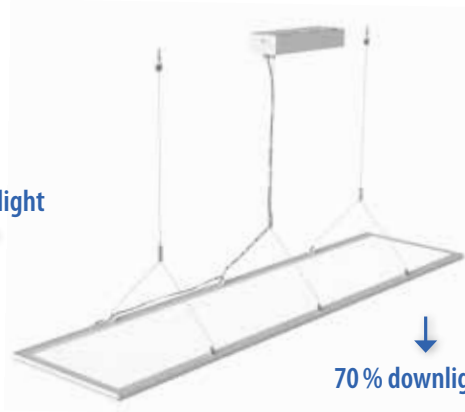

70 % downlight



Artikelnummer	Leistung	Spannung	Lichtfarbe	Farbtemperatur	mittlere Lebensdauer	Lichtstrom	Ausgangs-Strom	Abstrahlwinkel	Energieeffizienz	Maße L x B mm	Höhe mm
81-2062	40 W	230 V	warmweiß	3.000 K	40.000 h	3.720 lm	700 mA	110°	A+	295 x 1195	11
81-2063	40 W	230 V	weiß	4.000 K	40.000 h	4.000 lm	700 mA	110°	A+	295 x 1195	11

optional dimmbar mit LED Konverter Art.Nummer: 81-9012

- Leuchte mit Treiber (im Baldachin)
- Aluminiumgehäuse
- Rahmenfarbe: weiß
- inkl. Abhängeset



# LED EIN- / UNTERBAUPANEL inkl. Treiber

Leuchte besteht aus:



- Leuchte mit integriertem dim. Treiber (TRIAC) / Phasenabschnitt

Artikelnummer	Leistung	Spannung	Lichtfarbe	Farbtemperatur	mittlere Lebensdauer	Lichtstrom	Abstrahlwinkel	Energieeffizienz
81-3140	6 W	230 V	warmweiß	3.000 K	30.000 h	380 lm	90°	A+
81-3141	11 W	230 V	warmweiß	3.000 K	30.000 h	780 lm	90°	A+
81-3142	18 W	230 V	warmweiß	3.000 K	30.000 h	1.350 lm	90°	A+
81-3144	6 W	230 V	weiß	4.000 K	30.000 h	400 lm	90°	A+
81-3145	11 W	230 V	weiß	4.000 K	30.000 h	850 lm	90°	A+
81-3146	18 W	230 V	weiß	4.000 K	30.000 h	1.450 lm	90°	A+

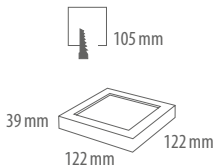

81-3140  
81-3141

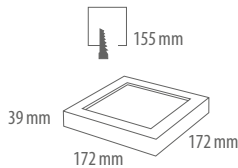

81-3142  
81-3144

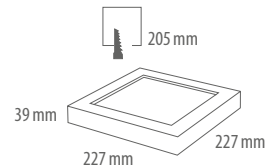

81-3145  
81-3146

Diese Leuchte enthält eingebaute LED. Diese LED können in der Leuchte nicht ausgetauscht werden.



Leuchte besteht aus:

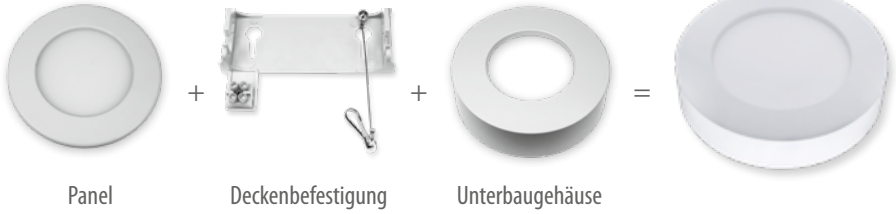

- Leuchte mit integriertem dim. Treiber (TRIAC) / Phasenabschnitt

Artikelnummer	Leistung	Spannung	Lichtfarbe	Farbtemperatur	mittlere Lebensdauer	Lichtstrom	Abstrahlwinkel	Energieeffizienz
81-3110	6 W	230 V	warmweiß	3.000 K	30.000 h	380 lm	90°	A+
81-3111	11 W	230 V	warmweiß	3.000 K	30.000 h	720 lm	90°	A+
81-3112	18 W	230 V	warmweiß	3.000 K	30.000 h	1.230 lm	90°	A+
81-3114	6 W	230 V	weiß	4.000 K	30.000 h	400 lm	90°	A+
81-3115	11 W	230 V	weiß	4.000 K	30.000 h	760 lm	90°	A+
81-3116	18 W	230 V	weiß	4.000 K	30.000 h	1.300 lm	90°	A+



127 mm

81-3110

81-3114

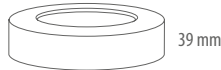

177 mm

81-3111

81-3115



227 mm

81-3112

81-3116



# 3 in 1 LED WAND-/ UNTERBAU-/ PENDELLEUCHE Jeannie



## Zwei mögliche Montagearten:

Deckenmontage

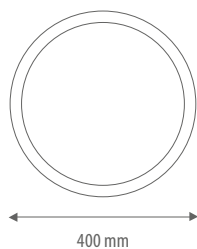

Pendelmontage

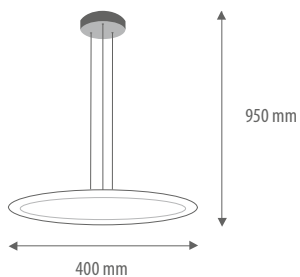

Diese Leuchte enthält eingebaute LED. Diese LED können in der Leuchte nicht ausgetauscht werden.



Artikelnummer	Leistung	Spannung	Lichtfarbe	Farbtemperatur	mittlere Lebensdauer	Lichtstrom	Ausgangs-Strom	Abstrahlwinkel	Energieeffizienz	Durchmesser mm	Höhe mm
81-4022	40 W	230 V	warmweiß	3.000 K	20.000 h	3.000 lm	190 mA	110°	A	400	24
81-4023	40 W	230 V	weiß	4.000 K	20.000 h	3.200 lm	190 mA	110°	A	400	24

- Leuchte mit integ. Treiber / nicht dimmbar
- Material: Kunststoff PC / PMMA
- inkl. Abhängeset



# SHOP-BELEUCHTUNG



## Shop-Beleuchtung, attraktiv und effizient

Als wichtiges Instrument zur Verkaufsförderung gilt die Lichtdramaturgie, die daher die Auswahl von Leuchten, Leuchtmitteln und Lichtsteuerung beeinflusst. Ein ebenso maßgebendes Kriterium ist die Energieeffizienz des Gesamtsystems – als Voraussetzung für Wirtschaftlichkeit und Erfolg.

In der Shop-Beleuchtung rechnet sich LED-Technologie schon nach kurzer Zeit – dank beeindruckend niedrigem Energieverbrauch und extrem langer Lebensdauer.

Bei der Shop-Beleuchtung steht immer das Einkaufserlebnis als sinnliche Erfahrung im Vordergrund. Dies gilt für das sortimentsreiche Kaufhaus ebenso wie für die edle Boutique, den exklusiven Feinkostladen oder den coolen Handy-Shop. Eines der wichtigsten Instrumente ist dabei die Lichtdramaturgie. Vor allem entscheiden die Leuchten mit ihren differenzierten Eigenschaften, wie Lichtfarbe und Farbwidrigkeit, zusammen mit Kontrasten und Lichtverteilung darüber, wie die Raumatmosphäre auf die Kunden wirkt: Eine kühle Anmutung in einem technikorientierten Geschäft oder eher warmtonig, wenn Kleidung oder Lederwaren offeriert werden, ausschließlich in edlem Weiß oder mit dynamischen Farbeffekten.

Die Lichtlösung als Instrument zur Verführung muss also genau auf das Ambiente und die zu inszenierenden Waren zugeschnitten sein. Dabei sind individuelle Store- und Marketing-Konzepte ebenso zu berücksichtigen, wie branchenübergreifende Anforderungen des Handels an die Beleuchtung. Diese Kriterien beeinflussen die Auswahl von Leuchten, Leuchtmitteln und Lichtsteuerung ebenso, wie die zugeordnete Funktion – Licht für die schnelle Orientierung über die Akzentuierung bis hin zur Inszenierung. In der Shop-Beleuchtung rechnet sich LED-Technologie schon nach kurzer Zeit – dank beeindruckend niedrigem Energieverbrauch und extrem langer Lebensdauer.

Quelle: licht.de



# LED SCHIENENSTRAHLER I. 3-Phasen / weiß



weiß

Artikelnummer	Leistung	Spannung	Lichtfarbe	Farbtemperatur	mittlere Lebensdauer	Lichtstrom	Abstrahlwinkel	Energieeffizienz	Länge wie Breite mm	Höhe mm
82-1200	10 W	230V	warmweiß	3.000 K	40.000 h	700 lm	24°	A+	siehe Zeichnung	
82-1201	10 W	230V	kaltweiß	5.000 K	40.000 h	725 lm	24°	A+		
82-1202	20 W	230V	warmweiß	3.000 K	40.000 h	1.700 lm	24°	A+		
82-1203	20 W	230V	kaltweiß	5.000 K	40.000 h	1.800 lm	24°	A+		
82-1204	30 W	230V	warmweiß	3.000 K	40.000 h	2.400 lm	24°	A+		
82-1205	30 W	230V	kaltweiß	5.000 K	40.000 h	2.500 lm	24°	A+		

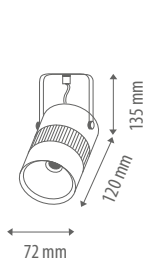

82-1206 82-1207  
82-1200 82-1201

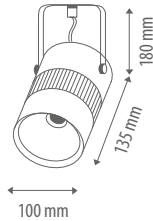

82-1208 82-1209  
82-1202 82-1203

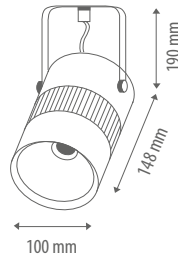

82-1210 82-1211  
82-1204 82-1205

Diese Leuchte enthält eingebaute LED. Diese LED können in der Leuchte nicht ausgetauscht werden.



silber

Artikelnummer	Leistung	Spannung	Lichtfarbe	Farbtemperatur	mittlere Lebensdauer	Lichtstrom	Abstrahlwinkel	Energieeffizienz	Länge wie Breite mm	Höhe mm
82-1206	10 W	230 V	warmweiß	3.000 K	40.000 h	700 lm	24°	A+	siehe Zeichnung	
82-1207	10 W	230 V	kaltweiß	5.000 K	40.000 h	725 lm	24°	A+		
82-1208	20 W	230 V	warmweiß	3.000 K	40.000 h	1.700 lm	24°	A+		
82-1209	20 W	230 V	kaltweiß	5.000 K	40.000 h	1.800 lm	24°	A+		
82-1210	30 W	230 V	warmweiß	3.000 K	40.000 h	2.400 lm	24°	A+		
82-1211	30 W	230 V	kaltweiß	5.000 K	40.000 h	2.500 lm	24°	A+		

- nicht dimmbar
- hohe Farbwiedergabe Ra >90
- Gehäusefarbe: silber/weiß



# LED SCHIENENSTRAHLER BRICK / 3-Phasen / weiß

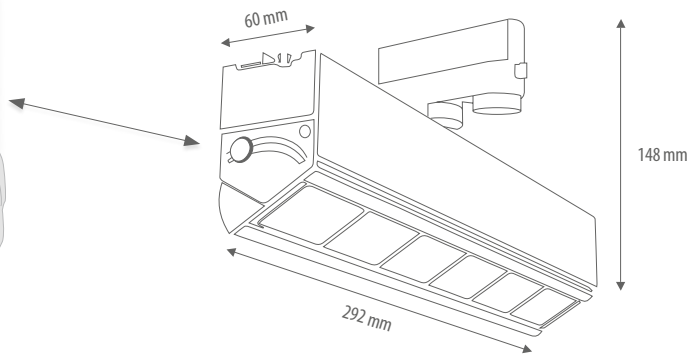
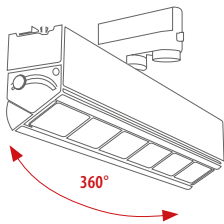

Diese Leuchte enthält eingebaute LED. Diese LED können in der Leuchte nicht ausgetauscht werden.

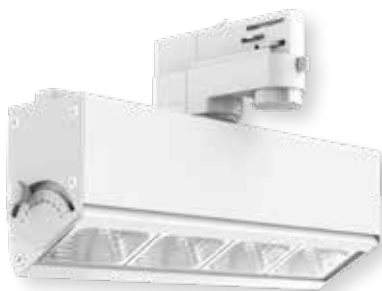

Lieferbar ab November 2018

Artikelnummer	Leistung	Spannung	Lichtfarbe	Farbtemperatur	mittlere Lebensdauer	Lichtstrom	Abstrahlwinkel	Energieeffizienz	Länge mm	Breite mm	Höhe mm
82-1217	27 W	230 V	warmweiß	3.000 K	50.000 h	3.200 lm	60°	A+	292	60	148
82-1218	27 W	230 V	weiß	4.000 K	50.000 h	3.300 lm	60°	A+	292	60	148

- nicht dimmbar
- hohe Farbwiedergabe Ra >80
- Gehäusefarbe: weiß
- Philips Treiber



# LED SCHIENENSTRAHLER SPOT / 3-Phasen

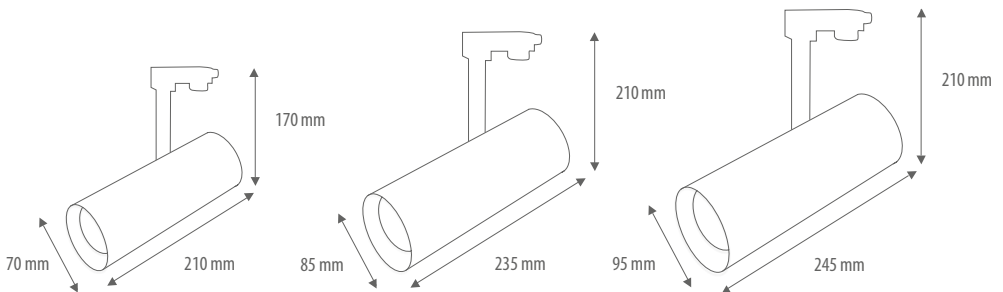

Diese Leuchte enthält eingebaute LED. Diese LED können in der Leuchte nicht ausgetauscht werden.



Lieferbar ab Januar 2019

! hohe Farbwiedergabe Ra = 97

Artikelnummer	Leistung	Spannung	Lichtfarbe	Farbtemperatur	mittlere Lebensdauer	Lichtstrom	Abstrahlwinkel	Energieeffizienz	Durchmesser mm	Länge mm	Höhe mm
Gehäuse weiß											
82-1220	10 W	230V	warmweiß	3.000 K	50.000 h	1.000 lm	24°	A+	70	210	170
82-1221	10 W	230V	kaltweiß	5.000 K	50.000 h	1.100 lm	24°	A+	70	210	170
82-1222	20 W	230V	warmweiß	3.000 K	50.000 h	2.000 lm	24°	A+	70	210	170
82-1223	20 W	230V	kaltweiß	5.000 K	50.000 h	2.100 lm	24°	A+	70	210	170
82-1224	30 W	230V	warmweiß	3.000 K	50.000 h	3.000 lm	24°	A+	85	235	210
82-1225	30 W	230V	kaltweiß	5.000 K	50.000 h	3.100 lm	24°	A+	85	235	210
82-1226	40 W	230V	warmweiß	3.000 K	50.000 h	4.000 lm	24°	A+	95	245	210
82-1227	40 W	230V	kaltweiß	5.000 K	50.000 h	4.100 lm	24°	A+	95	245	210

- inkl. Treiber, nicht dimmbar
- Aluminiumgehäuse



# LED SCHIENENSTRAHLER SPOT / 3-Phasen

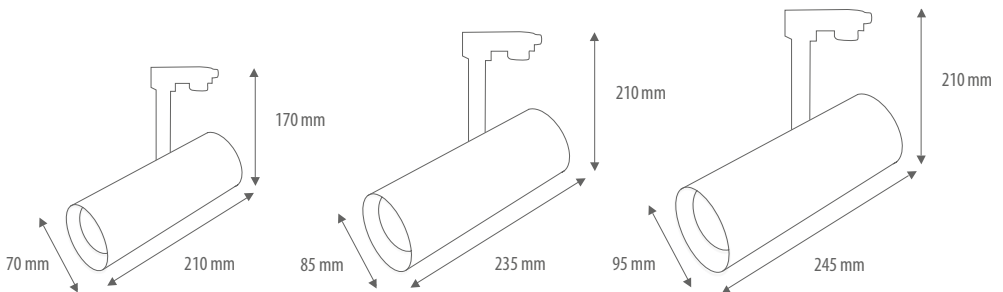

Diese Leuchte enthält eingebaute LED. Diese LED können in der Leuchte nicht ausgetauscht werden.



Lieferbar ab Januar 2019

! hohe Farbwiedergabe Ra = 97

Artikelnummer	Leistung	Spannung	Lichtfarbe	Farbtemperatur	mittlere Lebensdauer	Lichtstrom	Abstrahlwinkel	Energieeffizienz	Durchmesser mm	Länge mm	Höhe mm
Gehäuse silber											
82-1228	10 W	230V	warmweiß	3.000 K	50.000 h	1.000 lm	24°	A+	70	210	170
82-1229	10 W	230V	kaltweiß	5.000 K	50.000 h	1.100 lm	24°	A+	70	210	170
82-1230	20 W	230V	warmweiß	3.000 K	50.000 h	2.000 lm	24°	A+	70	210	170
82-1231	20 W	230V	kaltweiß	5.000 K	50.000 h	2.100 lm	24°	A+	70	210	170
82-1232	30 W	230V	warmweiß	3.000 K	50.000 h	3.000 lm	24°	A+	85	235	210
82-1233	30 W	230V	kaltweiß	5.000 K	50.000 h	3.100 lm	24°	A+	85	235	210
82-1234	40 W	230V	warmweiß	3.000 K	50.000 h	4.000 lm	24°	A+	95	245	210
82-1235	40 W	230V	kaltweiß	5.000 K	50.000 h	4.100 lm	24°	A+	95	245	210

- inkl. Treiber, nicht dimmbar
- Aluminiumgehäuse





# 3-Phasen-Schienen und Zubehör



Schienenverbinder / Aluminium zur Stabilisierung der Stoßstellen	
weiß	82-1050
silber	82-1150

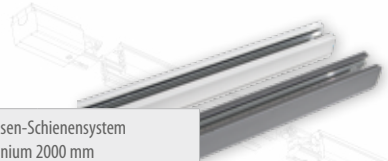

3-Phasen-Schiensystem Aluminium 2000 mm	
weiß	82-1000
silber	82-1100



L-Verbinder:	rechts	links
weiß	82-1035	82-1036
silber	82-1135	82-1136



Mitteleinspeisung	
weiß	82-1020
grau	82-1120

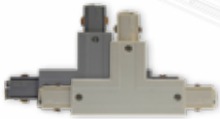

T-Verbinder:	rechts	links
weiß	82-1025	82-1027
grau	82-1125	82-1127

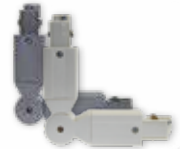

Uni-Verbinder	
weiß	82-1040
grau	82-1140

Für die elektrischen Komponenten Schienen, Einspeisungen, Verbinder gilt:

Spannung: 250 V max  
Strom: 16 A max

Für die EURO-Adapter gilt:

Spannung: 250 V max  
Strom: 10 A max  
Tragkraft: 100 N max



Einspeisung:	rechts	links
weiß	82-1005	82-1006
silber	82-1105	82-1106



Flexi-Verbinder	
weiß	82-1045
silber	82-1145



Euro-Adapter	
weiß	82-1065
grau	82-1165

Endkappe	
weiß	82-1010
silber	82-1110



X-Verbinder	
weiß	82-1030
silber	82-1130

Schienenverbinder	
weiß	82-1015
silber	82-1115



Seilabhangung	
weiß	82-1055
silber	82-1155



Seilabhangung fur Verbindungsstelle	
weiß	82-1060
silber	82-1160

# LED DECKENSTRAHLER schwenk-/ drehbar

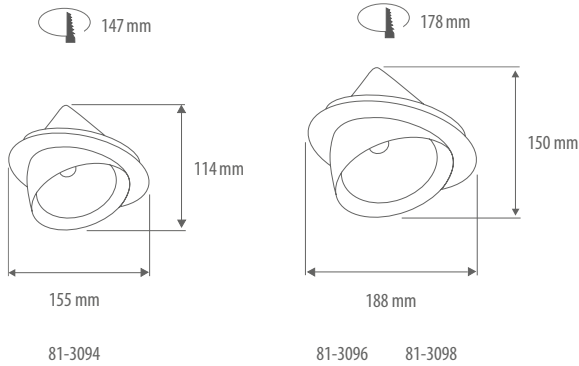

Diese Leuchte enthält eingebaute LED. Diese LED können in der Leuchte nicht ausgetauscht werden.



Artikelnummer	Leistung	Spannung	Lichtfarbe	Farbtemperatur	mittlere Lebensdauer	Lichtstrom	Ausgangs-Strom	Abstrahlwinkel	Energieeffizienz	Durchmesser mm	Höhe mm
81-3094	10W	230V	warmweiß	3.000 K	40.000 h	720lm	250 mA	24°	A+	155	114
81-3096	20W	230V	warmweiß	3.000 K	40.000 h	1.700 lm	500 mA	24°	A+	188	150
81-3098	40W	230V	warmweiß	3.000 K	40.000 h	3.200 lm	1.000 mA	24°	A+	188	150

- inkl. Treiber (extern)
- 350° drehbar
- 70° schwenkbar
- hohe Farbwiedergabe Ra>90



# LED SHOP-STRAHLER / schwenkbar

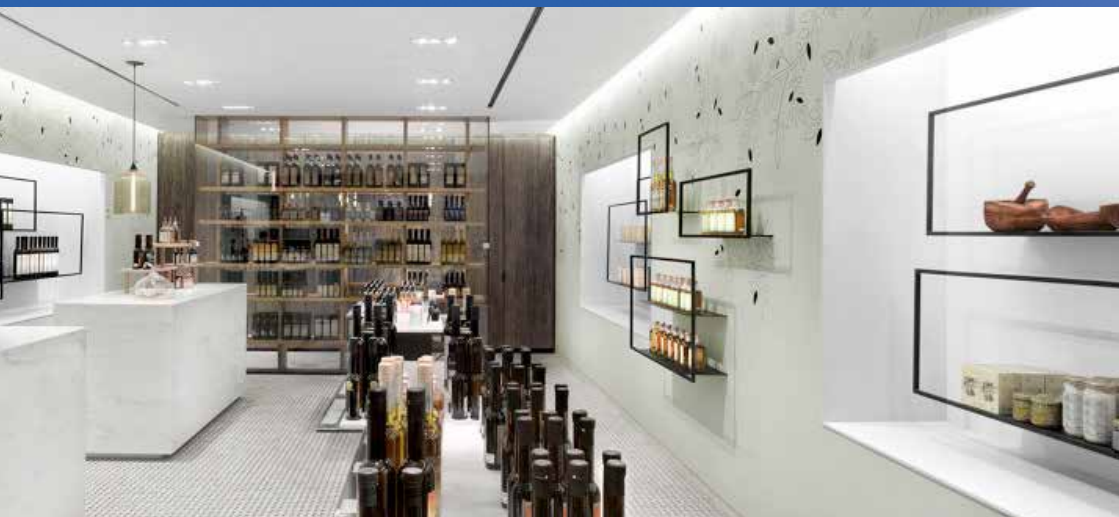

220 x 130 mm

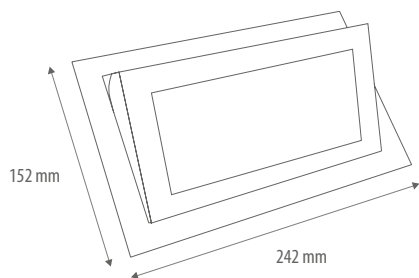

Diese Leuchte enthält eingebaute LED. Diese LED können in der Leuchte nicht ausgetauscht werden.



Artikelnummer	Leistung	Spannung	Lichtfarbe	Farbtemperatur	mittlere Lebensdauer	Lichtstrom	Ausgangs-Strom	Abstrahlwinkel	Energieeffizienz	Länge mm	Breite mm	Einbautiefe mm
81-3204	48 W	230 V	warmweiß	3.000 K	50.000 h	4.600 lm	1,2 A	80°	A+	242	152	90
81-3205	48 W	230 V	weiß	4.000 K	50.000 h	4.700 lm	1,2 A	80°	A+	242	152	90
81-3206	48 W	230 V	kaltweiß	6.000 K	50.000 h	4.700 lm	1,2 A	80°	A+	242	152	90

- hohe Farbwiedergabe Ra >80
- 60° schwenkbar
- Philips Vorschaltgerät
- Gehäusefarbe: weiß



# LED EINBAUSTRAHLER UND DOWNLIGHT



## Einbaustrahler finden überall Platz

LED-Einbauleuchten erfreuen sich immer größerer Beliebtheit. Einer der Hauptgründe hierfür ist ihre Effizienz. Sie bieten die Leuchtkraft einer herkömmlichen Lampe, verbrauchen dabei aber viel weniger Energie. Überdies sind LED-Leuchten mit unterschiedlichsten Lichttemperaturen erhältlich, sodass man für jeden Bedarf genau das richtige Modell findet.

Das Besondere an Einbauleuchten ist, dass sie in die Decke eingelassen werden und nahezu darin verschwinden. Dadurch steht das erzeugte Licht im Vordergrund, nicht die Lampe. Gegenüber Stehlampen oder Deckenfluter, haben die flachen Leuchten den Vorteil, dass sie keinen Platz einnehmen. Somit sind sie auch, aber nicht nur, für kleine Räumlichkeiten eine gute Lösung.

Außer in Wohnräumen werden LED Einbaustrahler gerne in Büros oder Geschäftsräumen verwendet. Für den Arbeitsplatz empfehlen sich kaltweiße LEDs, während zu Hause ein gemütliches warmweißes Licht die bessere Wahl ist.

## Downlight

Downlight hat sich als Bezeichnung für meist runde, mit Reflektoren und anderen optischen Elementen ausgestattete Deckenleuchten etabliert. Downlights, auch schwenkbare, sind für den Deckeneinbau (Einbau-Downlights) oder für den Deckenanbau (Anbau-Downlights) vorgesehen.

Deckeneinbauleuchten eignen sich zur Montage in Hohlräumen oder Zwischendecken. Der größte Teil der Leuchte ist nicht sichtbar in der Decke eingebaut, häufig schließt die Lichtaustrittsöffnung bündig mit der Decke ab.

Leuchten zur Montage direkt an der Decke sind Deckenanbauleuchten. Ihr Leuchtenkörper ist sichtbar. Sichtbare Leuchtenkörper wirken als Teil der Raumeinrichtung, sind damit auch Mittel der architektonischen Gestaltung.

Je nach Bauart des Reflektors entstehen unterschiedliche Lichtstärkeverteilungen und Ausstrahlungswinkel.



# LED COB GLASDOWNLIGHT

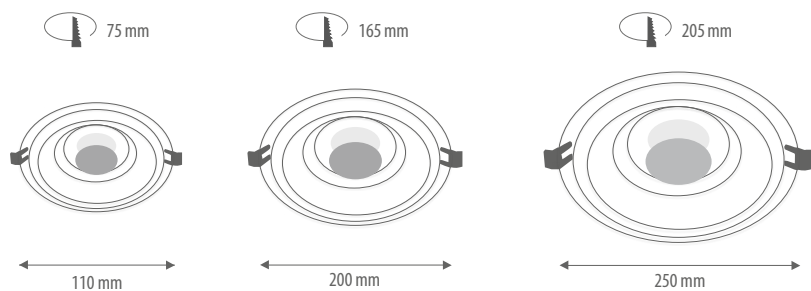



Lieferbar ab Januar 2019

Artikelnummer	Leistung	Spannung	Lichtfarbe	Farbtemperatur	mittlere Lebensdauer	Lichtstrom	Ausgangsstrom	Abstrahlwinkel	Energieeffizienz	Durchmesser mm	Einbautiefe mm (min.)	Höhe mm (i.A.)
81-4000	5 W	230 V	warmweiß	3.000 K	30.000 h	400 lm	280 mA	120°	A+	110	35	40
81-4001	15 W	230 V	warmweiß	3.000 K	30.000 h	1.200 lm	280 mA	120°	A+	200	35	40
81-4002	30 W	230 V	warmweiß	3.000 K	30.000 h	2.400 lm	850 mA	120°	A+	250	35	40
81-4003	5 W	230 V	weiß	4.000 K	30.000 h	450 lm	280 mA	120°	A+	110	35	40
81-4004	15 W	230 V	weiß	4.000 K	30.000 h	1.350 lm	280 mA	120°	A+	200	35	40
81-4005	30 W	230 V	weiß	4.000 K	30.000 h	2.700 lm	850 mA	120°	A+	250	35	40

- hohe Farbwiedergabe Ra>80
- inkl. Treiber (extern)
- nicht dimmbar
- Gehäuse: Aluminium
- Optik: gehärtetes Glas
- Zierring: PC



# EINBAULEUCHE SANDWICH / round

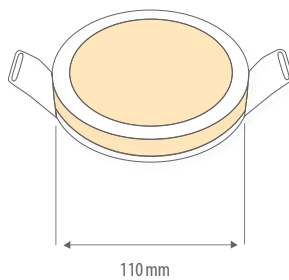
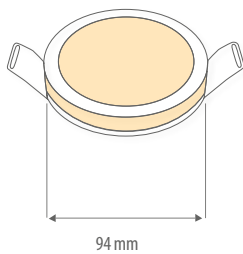
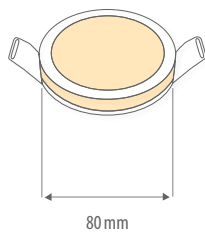

Diese Leuchte enthält eingebaute LED. Diese LED können in der Leuchte nicht ausgetauscht werden.



mit seitlichem Lichtkranz

Lieferbar ab November 2018

Artikelnummer	Leistung	Spannung	Lichtfarbe	Farbtemperatur	mittlere Lebensdauer	Lichtstrom	Ausgangs-Strom	Abstrahlwinkel	Energieeffizienz	Durchmesser mm	Höhe mm
round / eisen-gebürstet											
81-4050	5 W	230V	warm	3.000 K	50.000 h	430 lm	300 mA	100°	A+	80	35
81-4051	9 W	230V	warm	3.000 K	50.000 h	770 lm	300 mA	100°	A+	94	40
81-4052	15 W	230V	warm	3.000 K	50.000 h	1.280 lm	300 mA	100°	A+	110	45

- hohe Farbwiedergabe Ra > 80
- inkl. Treiber (extern)
- nicht dimmbar
- Gehäuse: Aluminium
- Optik: PMMA



# EINBAULEUCHE SANDWICH / square



Produktbeispiel: weiß

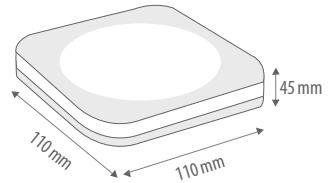
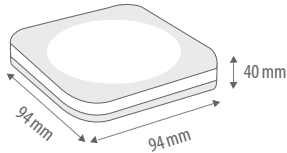
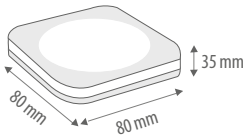

Diese Leuchte enthält eingebaute LED. Diese LED können in der Leuchte nicht ausgetauscht werden.



mit seitlichem Lichtkranz

Lieferbar ab Januar 2019

Artikelnummer	Leistung	Spannung	Lichtfarbe	Farbtemperatur	mittlere Lebensdauer	Lichtstrom	Ausgangs-Strom	Abstrahlwinkel	Energieeffizienz	Länge wie Breite mm	Höhe mm
square / eisen-gebürstet											
81-4053	5 W	230 V	warmweiß	3.000 K	40.000 h	420 lm	300 mA	100°	A <sup>+</sup>	80	35
81-4054	9 W	230 V	warmweiß	3.000 K	40.000 h	770 lm	300 mA	100°	A <sup>+</sup>	94	40
81-4055	15 W	230 V	warmweiß	3.000 K	40.000 h	1.250 lm	300 mA	100°	A <sup>+</sup>	110	45

- hohe Farbwiedergabe Ra > 80
- inkl. Treiber (extern)
- nicht dimmbar
- Gehäuse: Aluminium
- Optik: PMMA



Ra(CRI) > 80

optimal -10° - 30°

# LED EINBAUSPOT IP65



eisen-gebürstet  
im Lieferumfang



weiß  
im Lieferumfang

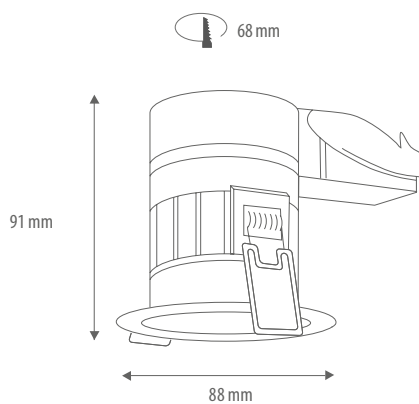



Lieferbar ab Januar 2019

IP65

Artikelnummer	Leistung	Spannung	Lichtfarbe	Farbtemperatur	mittlere Lebensdauer	Lichtstrom	Ausgangs-Strom	Abstrahlwinkel	Energieeffizienz	Durchmesser mm	Höhe mm
81-4046	10 W	230 V	warmweiß	3.000 K	40.000 h	750 lm	220 mA	36°	A+	88	91

- hohe Farbwiedergabe  $R_a > 80$
- inkl. Treiber, dimmbar, (Phasenabschnitt)
- Anschlussbox mit Zugentlastung
- Gehäuse: Aluminium
- Optik: PMMA
- Verschlussring: Aluminium / Glas
- Verschlussring wechselbar: weiß und eisen-gebürstet
- geprüft nach Norm BS 476-21





# COB STRAHLER round



81-3059  
eisen-gebürstet



81-3060  
weiß

## Oberfläche plan

Artikelnummer	Leistung	Spannung	Lichtfarbe	Farbtemperatur	mittlere Lebensdauer	Lichtstrom	Ausgangs-Strom	Abstrahlwinkel	Energieeffizienz	Durchmesser mm	Höhe mm
81-3059	5W	230V	warmweiß	3.000 K	50.000 h	400 lm	350 mA	24°	A <sup>+</sup>	88	42
81-3060	5W	230V	warmweiß	3.000 K	50.000 h	400 lm	350 mA	24°	A <sup>+</sup>	88	42

optional dimmbar mit LED Konverter Art.Nummer: 81-9013

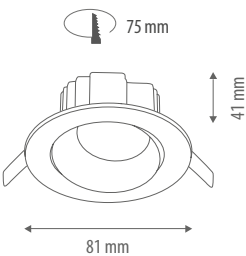

Diese Leuchte enthält eingebaute LED. Diese LED können in der Leuchte nicht ausgetauscht werden.



81-3055  
eisen-gebürstet



81-3056  
weiß

Oberfläche gerundet

Artikelnummer	Leistung	Spannung	Lichtfarbe	Farbtemperatur	mittlere Lebensdauer	Lichtstrom	Ausgangs-Strom	Abstrahlwinkel	Energieeffizienz	Durchmesser mm	Höhe mm
81-3055	5W	230V	warmweiß	3.000 K	50.000 h	400 lm	350 mA	24°	A+	81	41
81-3056	5W	230V	warmweiß	3.000 K	50.000 h	400 lm	350 mA	24°	A+	81	41

optional dimmbar mit LED Konverter Art.Nummer: 81-9013

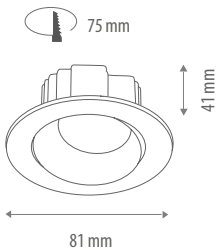

# COB STRAHLER square

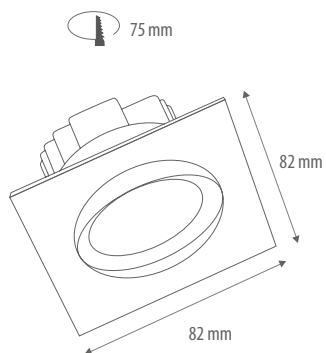

Diese Leuchte enthält eingebaute LED. Diese LED können in der Leuchte nicht ausgetauscht werden.



81-3057  
eisen-gebürstet



81-3058  
weiß

Artikelnummer	Leistung	Spannung	Lichtfarbe	Farbtemperatur	mittlere Lebensdauer	Lichtstrom	Ausgangs-Strom	Abstrahlwinkel	Energieeffizienz	Durchmesser mm	Höhe mm
81-3057	5 W	230V	warmweiß	3.000 K	50.000 h	400 lm	350 mA	24°	A+	82	41
81-3058	5 W	230V	warmweiß	3.000 K	50.000 h	400 lm	350 mA	24°	A+	82	41

- optional dimmbar mit LED Konverter: 81-9013



# LED STRAHLER / Sandie mit Wechselring

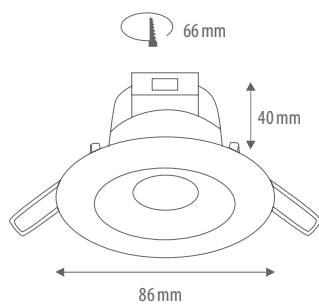

81-5054 81-5055

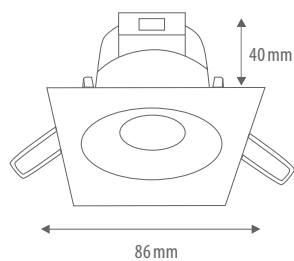

81-5056 81-5057

Diese Leuchte enthält eingebaute LED. Diese LED können in der Leuchte nicht ausgetauscht werden.

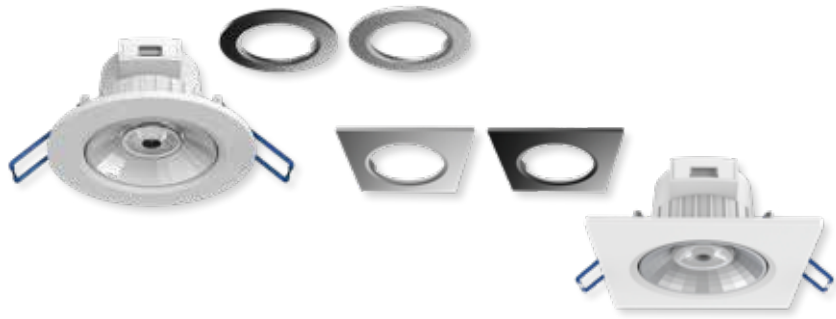

Artikelnummer	Leistung	Spannung	Lichtfarbe	Farbtemperatur	mittlere Lebensdauer	Lichtstrom	Ausgangs-Strom	Abstrahlwinkel	Energieeffizienz	Durchmesser mm	Höhe mm
<b>round</b>											
81-5054	5,5 W	230 V	warmweiß	2.700 K	50.000 h	345 lm	300 mA	38°	A+	86	40
81-5055	5,5 W	230 V	weiß	4.000 K	50.000 h	360 lm	300 mA	38°	A+	86	40
<b>square</b>											
81-5056	5,5 W	230 V	warmweiß	2.700 K	50.000 h	345 lm	300 mA	38°	A+	86	40
81-5057	5,5 W	230 V	weiß	4.000 K	50.000 h	360 lm	300 mA	38°	A+	86	40

- Kunststoffgehäuse mit ALU-Kern
- schwenkbar
- inkl. 3 x Wechselring: weiß, schwarz und silber
- dimmbar (TRIAC) / Phasenabschnitt



# LED STRAHLER / Melody



 68 mm – 75 mm

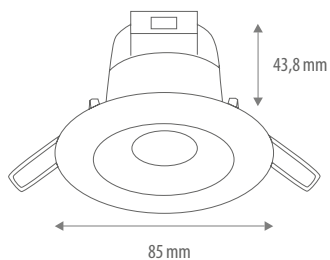

81-3252

81-3253

Diese Leuchte enthält eingebaute LED. Diese LED können in der Leuchte nicht ausgetauscht werden.



Artikelnummer	Leistung	Spannung	Lichtfarbe	Farbtemperatur	mittlere Lebensdauer	Lichtstrom	Ausgangs-Strom	Abstrahlwinkel	Energieeffizienz	Durchmesser mm	Höhe mm
81-3252	6,5 W	230V	warmweiß	3.000 K	40.000 h	550 lm	90 mA	36°	A+	85	43,8
81-3253	6,5 W	230V	weiß	4.000 K	40.000 h	600 lm	90 mA	36°	A+	85	43,8

- Kunststoffgehäuse
- schwenkbar
- dimmbar (TRIAC) / Phasenabschnitt





# FLAT LED Modul / Keramik

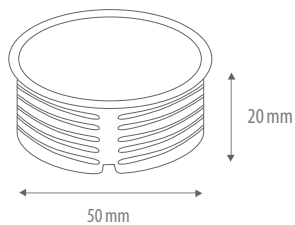



Lieferbar ab Oktober 2018

Scheibe: matt

Artikelnummer	Leistung	Spannung	Lichtfarbe	Farbtemperatur	mittlere Lebensdauer	Lichtstrom	Abstrahlwinkel	Energieeffizienz	Durchmesser mm	Höhe mm
81-3258	5 W	230V	warmweiß	3.000 K	40.000 h	350 lm	130°	A	50	20
81-3259	5 W	230V	weiß	4.000 K	40.000 h	370 lm	130°	A	50	20

- LED-MODULE
- Keramik Körper für optimale Kühlung
- direkter Anschluß an 230 V
- die Alternative zu GU10
- dimmbar (Phasenanschnitt)





02-1001

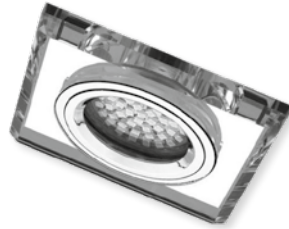

02-1000

Hochwertige Einbaustrahler aus Klarglas / Aluminium

Artikelnummer	Leistung max	Farbe	Fassung	Strahler Ø mm	Bohrloch Ø mm
02-1001	50W	klar	MR16	90	61
02-1000	50W	klar	MR16	90 x 90	61

Lieferung ohne Leuchtmittel!

Einbaustrahler für Halogen-/ LED-Lampen Ø 50 mm mit Fassung GU 5.3.

## Produkteigenschaften

- Glas / Aluminium
- starr
- drehbarer Innenring (Click)
- Befestigung durch Spreizfedern
- Auch für Hochvolt-LED Lampen 230V
- Fassung GU10 separat bestellen  
Best.-Nr. 01-4080

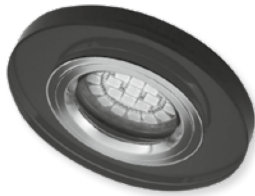

02-1003



02-1002

### Hochwertige Einbaustrahler aus Schwarzglas / Aluminium

Artikelnummer	Leistung max	Farbe	Fassung	Strahler $\varnothing$ mm	Bohrloch $\varnothing$ mm
02-1003	50W	schwarz	MR16	90	61
02-1002	50W	schwarz	MR16	90 x 90	61

Lieferung ohne Leuchtmittel!

Einbaustrahler für Halogen-/LED-Lampen  $\varnothing$  50 mm mit Fassung GU 5.3.



# LED DOWNLIGHT / Gracie



81-3150 81-3155



81-3151 81-3156

Artikelnummer	Leistung	Spannung	Lichtfarbe	Farbtemperatur	mittlere Lebensdauer	Lichtstrom	Ausgangs-Strom	Abstrahlwinkel	Energieeffizienz
81-3150	7W	230V	warmweiß	3.000 K	30.000 h	520 lm	90 mA	90°	A+
81-3155	7W	230V	weiß	4.000 K	30.000 h	550 lm	90 mA	90°	A+
81-3151	10W	230V	warmweiß	3.000 K	30.000 h	760 lm	70 mA	90°	A+
81-3156	10W	230V	weiß	4.000 K	30.000 h	840 lm	70 mA	90°	A+

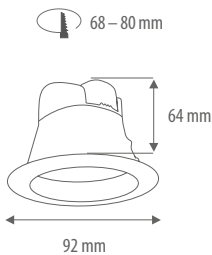

81-3150 81-3155

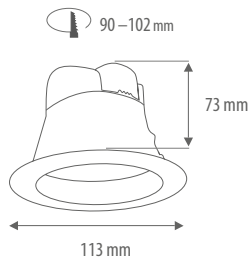

81-3151 81-3156

Diese Leuchte enthält eingebaute LED. Diese LED können in der Leuchte nicht ausgetauscht werden.



81-3152 81-3157



81-3153 81-3158



81-3154 81-3159

Artikelnummer	Leistung	Spannung	Lichtfarbe	Farbtemperatur	mittlere Lebensdauer	Lichtstrom	Ausgangs-Strom	Abstrahlwinkel	Energieeffizienz
81-3152	14W	230V	warmweiß	3.000 K	30.000 h	1.070 lm	100 mA	90°	A+
81-3157	14W	230V	weiß	4.000 K	30.000 h	1.220 lm	100 mA	90°	A+
81-3153	17W	230V	warmweiß	3.000 K	30.000 h	1.280 lm	130 mA	90°	A+
81-3158	17W	230V	weiß	4.000 K	30.000 h	1.500 lm	130 mA	90°	A+
81-3154	25W	230V	warmweiß	3.000 K	30.000 h	2.200 lm	180 mA	90°	A+
81-3159	25W	230V	weiß	4.000 K	30.000 h	2.350 lm	180 mA	90°	A+

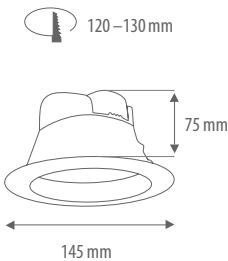

81-3152 81-3157

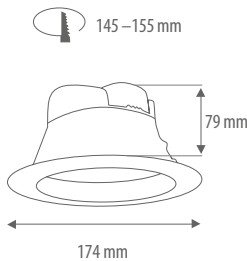

81-3153 81-3158

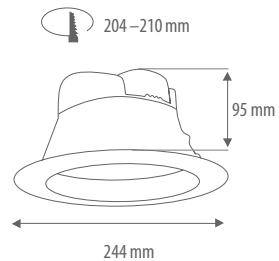

81-3154 81-3159



# REDUZIERRING FÜR DOWNLIGHT-SERIE / Gracie





82-105 mm



102-135 mm



132-155 mm



81-3164



81-3165



81-3166



68-80 mm

81-3150 / 81-3155



90-102 mm

81-3151 / 81-3156



120-130 mm

81-3152 / 81-3157



156-195 mm



81-3167



215-260 mm



81-3168



145-155 mm

81-3153 / 81-3158



195-210 mm

81-3154 / 81-3159



# ZUBEHÖR für LED Downlight / Gracie / Dekorring



Artikelnummer Dekorring chrom-matt	Außendurchmesser mm	Passend für Artikel
89-2010	Ø 95	81-3150 / 81-3155
89-2011	Ø 113	81-3151 / 81-3156
89-2012	Ø 145	81-3152 / 81-3157
89-2013	Ø 175	81-3153 / 81-3158
89-2014	Ø 244	81-3154 / 81-3159

81-3150/81-3155



Dekorring chrom-matt

89-2010

81-3151/81-3156



Dekorring chrom-matt

89-2011

81-3152/81-3157



Dekorring chrom-matt

89-2012

81-3153/81-3158



Dekorring chrom-matt

89-2013

81-3154/81-3159



Dekorring chrom-matt

89-2014

# LED DOWNLIGHT mit Farbwahl



 240 mm – 255 mm

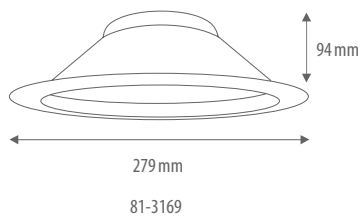

Diese Leuchte enthält eingebaute LED. Diese LED können in der Leuchte nicht ausgetauscht werden.



Artikelnummer	Leistung	Spannung	Lichtfarbe	Farbtemperatur	mittlere Lebensdauer	Lichtstrom	Ausgangs-Strom	Abstrahlwinkel	Energieeffizienz	Durchmesser mm	Höhe mm
81-3169	40 W	230V	warmweiß	3.000 K	45.000 h	3.600 lm	1050 mA	90°	A+	279	94
	40 W	230V	weiß	4.000 K	45.000 h	4.150 lm	1050 mA	90°	A+	279	94
	40 W	230V	kaltweiß	6.000 K	45.000 h	4.150 lm	1050 mA	90°	A+	279	94

Über einen Schalter auf der Rückseite der Leuchte, können Sie zwischen den Lichtfarben  
 • 3.000 K, 4.000 K und 6.000 K wählen.

- dimmbar (1–10V)
- DALI dimmbar mit Treiber 81-9018



# WAND / DECKENLEUCHE JADE

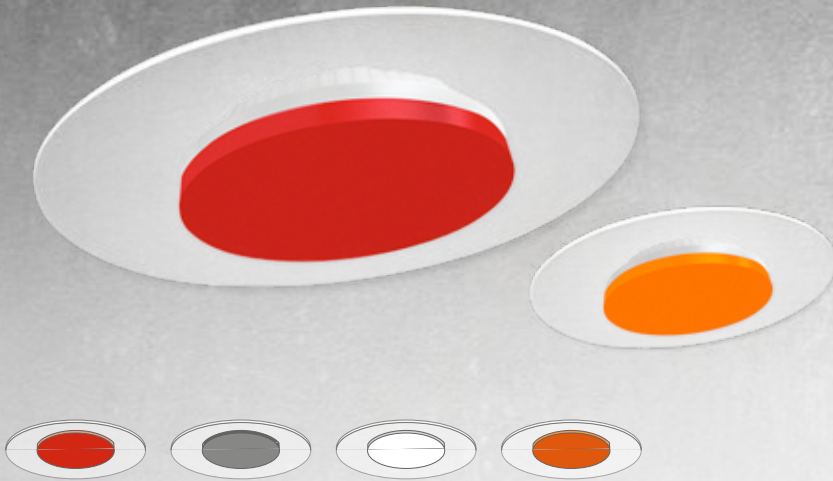

Der Microdruck im Acrylglasring (PMMA) setzt besondere Lichteffekte

Mittenabdeckung austauschbar

Optionale Farben für Mittenabdeckung

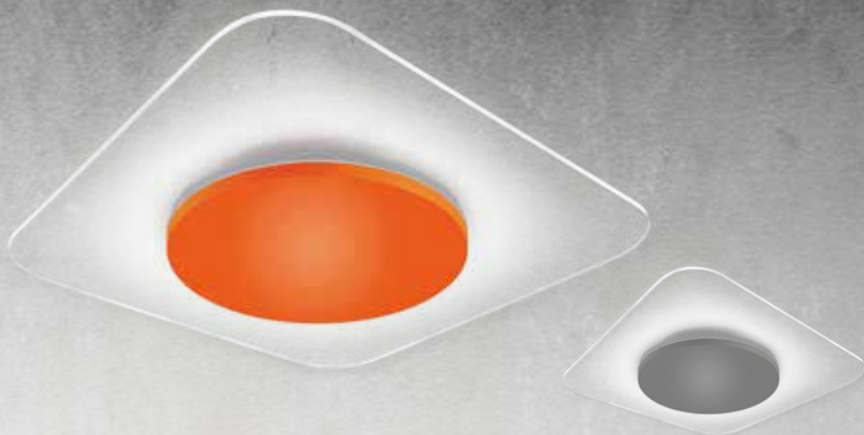

Artikelnummer	Farbe	Durchmesser mm	passend für
Wechselcover für JADE 12 W (round + square)			
89-2040	weiß	163	81-4070, 81-4073, 81-4076, 81-4079
89-2041	rot	163	
89-2042	orange	163	
89-2043	silber	163	
Wechselcover für JADE 18 W und 24 W (round + square)			
89-2044	weiß	212	81-4071, 81-4072, 81-4074, 81-4075 81-4077, 81-4078, 81-4080, 81-4081
89-2045	rot	212	
89-2046	orange	212	
89-2047	silber	212	



# WAND / DECKENLEUCHE / JADE / round



290 mm



370 mm



420 mm

Diese Leuchte enthält eingebaute LED. Diese LED können in der Leuchte nicht ausgetauscht werden.

neu

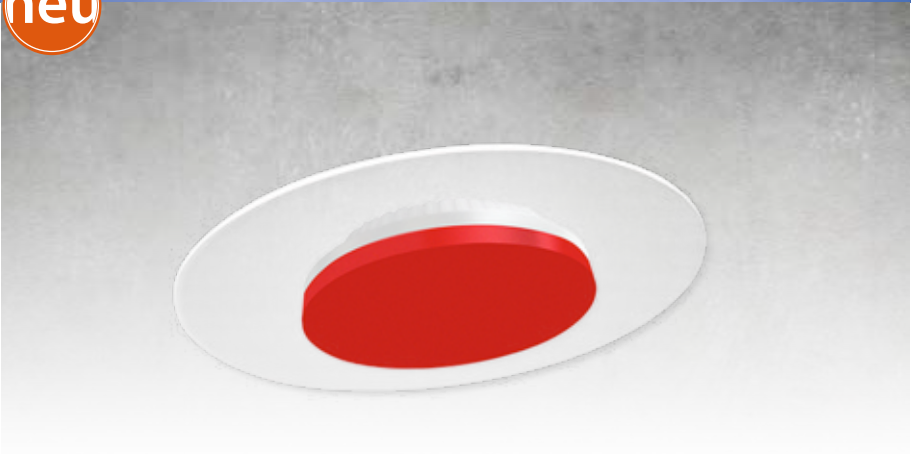

Lieferbar ab Januar 2019

Artikelnummer	Leistung	Spannung	Lichtfarbe	Farbtemperatur	mittlere Lebensdauer	Lichtstrom	Ausgangs-Strom	Abstrahlwinkel	Energieeffizienz	Durchmesser mm	Höhe mm
round											
81-4070	12 W	230 V	warmweiß	3.000 K	50.000 h	1.150 lm	350 mA	120°	A+	290	42
81-4071	18 W	230 V	warmweiß	3.000 K	50.000 h	1.700 lm	350 mA	120°	A+	370	46
81-4072	24 W	230 V	warmweiß	3.000 K	50.000 h	2.300 lm	700 mA	120°	A+	420	46
81-4073	12 W	230 V	weiß	4.000 K	50.000 h	1.200 lm	350 mA	120°	A+	290	42
81-4074	18 W	230 V	weiß	4.000 K	50.000 h	1.800 lm	350 mA	120°	A+	370	46
81-4075	24 W	230 V	weiß	4.000 K	50.000 h	2.400 lm	700 mA	120°	A+	420	46

- farbige Mittenabdeckung austauschbar (Silber = Standard)
- optionale Farben: weiß, rot, orange ... siehe Seite 123
- nicht dimmbar
- hohe Farbwiedergabe Ra > 80
- Gehäuse: Aluminium
- Optik: PMMA





# WAND / DECKENLEUCHE / JADE / square

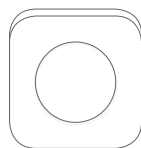

290 mm



350 mm

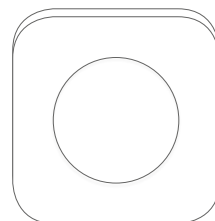

390 mm

Diese Leuchte enthält eingebaute LED. Diese LED können in der Leuchte nicht ausgetauscht werden.

neu



Lieferbar ab Januar 2019

Artikelnummer	Leistung	Spannung	Lichtfarbe	Farbtemperatur	mittlere Lebensdauer	Lichtstrom	Ausgangs-Strom	Abstrahlwinkel	Energieeffizienz	Länge wie Breite mm	Höhe mm
round											
81-4076	12 W	230V	warmweiß	3.000 K	50.000 h	1.150 lm	350 mA	120°	A+	290	42
81-4077	18 W	230V	warmweiß	3.000 K	50.000 h	1.700 lm	350 mA	120°	A+	350	46
81-4078	24 W	230V	warmweiß	3.000 K	50.000 h	2.300 lm	700 mA	120°	A+	390	46
81-4079	12 W	230V	weiß	4.000 K	50.000 h	1.200 lm	350 mA	120°	A+	290	42
81-4080	18 W	230V	weiß	4.000 K	50.000 h	1.800 lm	350 mA	120°	A+	350	46
81-4081	24 W	230V	weiß	4.000 K	50.000 h	2.400 lm	700 mA	120°	A+	390	46

- farbige Mittenabdeckung austauschbar (Silber = Standard)
- optionale Farben: weiß, rot, orange ... siehe Seite 123
- nicht dimmbar
- hohe Farbwiedergabe Ra>80
- Gehäuse: Aluminium
- Optik: PMMA



# LED DECKENLEUCHE



Artikelnummer	Leistung	Spannung	Lichtfarbe	Farbtemperatur	mittlere Lebensdauer	Lichtstrom	Ausgangs-Strom	Abstrahlwinkel	Energieeffizienz	Durchmesser mm	Höhe mm
81-3031	8 W	230 V	warmweiß	3.000 K	40.000 h	560 lm	90 mA	120°	A <sup>+</sup>	180	70
81-3032	8 W	230 V	weiß	4.000 K	40.000 h	600 lm	90 mA	120°	A <sup>+</sup>	180	70
81-3042	16 W	230 V	warmweiß	3.000 K	40.000 h	1.280 lm	240 mA	120°	A <sup>+</sup>	280	95
81-3040	16 W	230 V	weiß	4.000 K	40.000 h	1.360 lm	240 mA	120°	A <sup>+</sup>	280	95
81-3034	22 W	230 V	warmweiß	3.000 K	40.000 h	1.760 lm	270 mA	120°	A <sup>+</sup>	410	115
81-3035	22 W	230 V	weiß	4.000 K	40.000 h	1.980 lm	270 mA	120°	A <sup>+</sup>	410	115

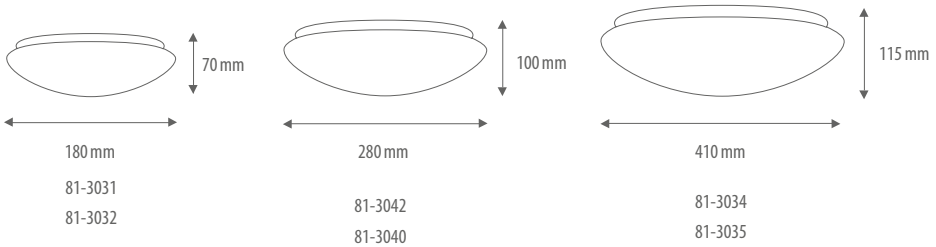

Diese Leuchte enthält eingebaute LED. Diese LED können in der Leuchte nicht ausgetauscht werden.

## LED Deckenleuchte für eine optimale Ausleuchtung im Innenbereich

- Acrylbedeckung (PMMA)
- Gehäuse: Stahlblech

NEU  
NEU

Artikelnummer	Leistung	Spannung	Lichtfarbe	Farbtemperatur	mittlere Lebensdauer	Lichtstrom	Ausgangs-Strom	Abstrahlwinkel	Energieeffizienz	Durchmesser mm	Höhe mm
81-3044	32 W	230V	warmweiß	3.000 K	40.000 h	2.560 lm	270 mA	120°	A <sup>+</sup>	410	115
81-3041	32 W	230V	weiß	4.000 K	40.000 h	2.880 lm	270 mA	120°	A <sup>+</sup>	410	115
81-3028	40 W	230V	warmweiß	3.000 K	40.000 h	3.850 lm	1.050 mA	120°	A <sup>+</sup>	500	140
81-3029	40 W	230V	weiß	4.000 K	40.000 h	4.164 lm	1.050 mA	120°	A <sup>+</sup>	500	140

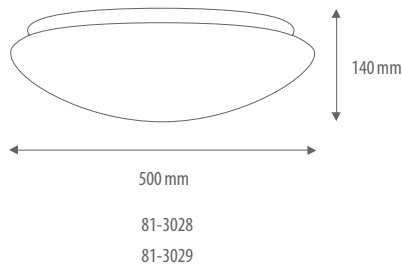
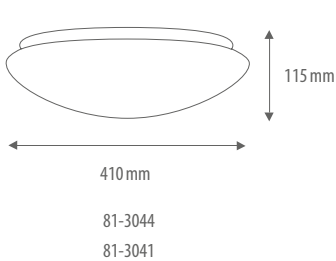

# LED DECKENLEUCHE mit Bewegungssensor



Artikelnummer	Leistung	Spannung	mittlere Lebensdauer	Länge mm	breite mm	Höhe mm
81-3245	400 W – 800 W*	230 V	30.000 h	72	35,5	25,5

ON ↑ 		1	2	3	
	I	on	on	on	100%
	II		on	on	75%
	III	on		on	50%
	IV			on	25
	VI				10

ON ↑ 		4	5	6	
	I	on	on	on	5s
	II		on	on	30s
	III	on		on	90s
	IV			on	3 min
	V	on	on		20 min
	VI				30 min

ON ↑ 		7	8	9	
	I	on	on	on	2 lux
	II	on	on		10 lux
	III		on		30 lux
	IV	on			50 lux
	V				abgeschaltet

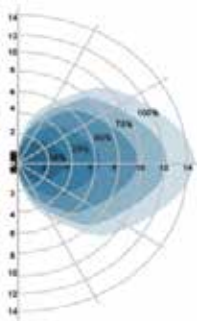

Wandmontage 150°  
Installationshöhe 1 – 1,8 m

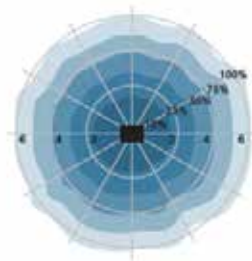

Deckenmontage 360°  
Installationshöhe 2,5 – 3 m

\* 400 W -Leuchtstofflampe  
800 W Standardlampe



Artikelnummer	Leistung	Spannung	Lichtfarbe	Farbtemperatur	mittlere Lebensdauer	Lichtstrom	Ausgangs-Strom	Abstrahlwinkel	Energieeffizienz	Durchmesser mm	Höhe mm
81-3242	16 W	230 V	warmweiß	3.000 K	40.000 h	1.280 lm	240 mA	120°	A+	280	95
81-3240	16 W	230 V	weiß	4.000 K	40.000 h	1.360 lm	240 mA	120°	A+	280	95
81-3246	22 W	230 V	warmweiß	3.000 K	40.000 h	1.760 lm	270 mA	120°	A+	410	115
81-3247	22 W	230 V	weiß	4.000 K	40.000 h	1.950 lm	270 mA	120°	A+	410	115
81-3244	32 W	230 V	warmweiß	3.000 K	40.000 h	2.560 lm	270 mA	120°	A+	410	115
81-3241	32 W	230 V	weiß	4.000 K	40.000 h	2.880 lm	270 mA	120°	A+	410	115

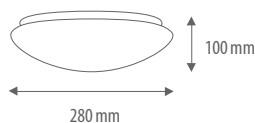

81-3242 81-3240

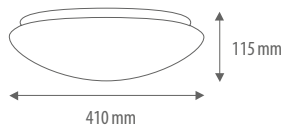

81-3244 81-3246 81-3241 81-3247



Diese Leuchte enthält eingebaute LED. Diese LED können in der Leuchte nicht ausgetauscht werden.



# LED DECKENLEUCHTE / Valuna

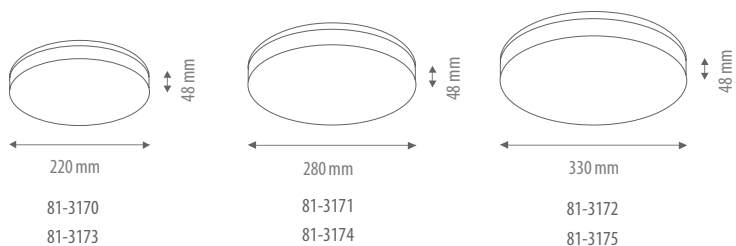

Diese Leuchte enthält eingebaute LED. Diese LED können in der Leuchte nicht ausgetauscht werden.



Artikelnummer	Leistung	Spannung	Lichtfarbe	Farbtemperatur	mittlere Lebensdauer	Lichtstrom	Ausgangs-Strom	Abstrahlwinkel	Energieeffizienz	Durchmesser mm	Höhe mm
81-3170	15 W	230 V	warmweiß	3.000 K	30.000 h	1.200 lm	215 mA	120°	A+	220	48
81-3171	18 W	230 V	warmweiß	3.000 K	30.000 h	1.400 lm	250 mA	120°	A+	280	48
81-3172	24 W	230 V	warmweiß	3.000 K	30.000 h	1.900 lm	310 mA	120°	A+	330	48
81-3173	15 W	230 V	weiß	4.000 K	30.000 h	1.250 lm	215 mA	120°	A+	220	48
81-3174	18 W	230 V	weiß	4.000 K	30.000 h	1.500 lm	250 mA	120°	A+	280	48
81-3175	24 W	230 V	weiß	4.000 K	30.000 h	2.050 lm	210 mA	120°	A+	330	48

- LED-Leuchte für Netzspannung 230V
- hohe Farbwiedergabe Ra > 80
- nicht dimmbar
- Gehäusefarbe: weiß





# LED DECKENLEUCHE / Valuna

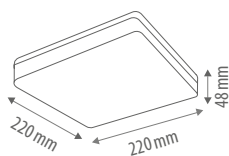

81-3176

81-3179

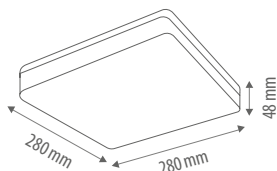

81-3177

81-3180

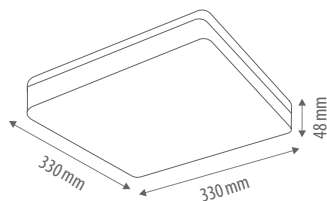

81-3178

81-3181

Diese Leuchte enthält eingebaute LED. Diese LED können in der Leuchte nicht ausgetauscht werden.



Artikelnummer	Leistung	Spannung	Lichtfarbe	Farbtemperatur	mittlere Lebensdauer	Lichtstrom	Ausgangs-Strom	Abstrahlwinkel	Energieeffizienz	L x B mm	Höhe mm
81-3176	15 W	230 V	warmweiß	3.000 K	30.000 h	1.200 lm	215 mA	120°	A <sup>+</sup>	220	48
81-3177	18 W	230 V	warmweiß	3.000 K	30.000 h	1.400 lm	250 mA	120°	A <sup>+</sup>	280	48
81-3178	24 W	230 V	warmweiß	3.000 K	30.000 h	1.900 lm	320 mA	120°	A <sup>+</sup>	330	48
81-3179	15 W	230 V	weiß	4.000 K	30.000 h	1.250 lm	215 mA	120°	A <sup>+</sup>	220	48
81-3180	18 W	230 V	weiß	4.000 K	30.000 h	1.500 lm	250 mA	120°	A <sup>+</sup>	280	48
81-3181	24 W	230 V	weiß	4.000 K	30.000 h	2.050 lm	320 mA	120°	A <sup>+</sup>	330	48

- LED-Leuchte für Netzspannung 230V
- hohe Farbwiedergabe Ra > 80
- nicht dimmbar
- Gehäusefarbe: weiß



# LED BADEZIMMERLEUCHE



Diese Leuchte enthält eingebaute LED. Diese LED können in der Leuchte nicht ausgetauscht werden.



Endkappen wechselbar (inkl.)

NEU

Artikelnummer	Leistung	Spannung	Lichtfarbe	Farbtemperatur	mittlere Lebensdauer	Lichtstrom	Ausgangs-Strom	Abstrahlwinkel	Energieeffizienz	Länge x Breite mm	Höhe mm
81-3194	15 W	230 V	warmweiß	3.000 K	30.000 h	1.200 lm	180 mA	135°	A+	600 x 52	69
81-3195	15 W	230 V	weiß	4.000 K	30.000 h	1.200 lm	180 mA	135°	A+	600 x 52	69

- Material: Polycarbonat weiß / opal
- Anschluß mittig auf der Rückseite
- wechselbare Endkappen, weiß / chrom
- Schalter



# LED NEONFLEX / IP 65



## Treiberempfehlung:

Artikelnummer	Spannung	Leistung	für
Netzteile			
81-9030	24V/DC	50 W	5 m
81-9031	24V/DC	80 W	10 m
Zubehör			
89-4013	Clip		
89-4014	Endkappe		
89-4015	Einspeisung		

Set beinhaltet jeweils:

- 5m / 10m Neonflex, PVC
- 1 x Endkappe (konfektioniert)
- 1 x Einspeisung (konfektioniert)
- 10x / 20x Befestigungsclip



Lieferbar ab Januar 2019

Artikelnummer	Leistung / Meter	Leistung / Gesamt	Lichtfarbe	Farbtemperatur / Wellenlänge	mittlere Lebensdauer	Lichtstrom / Meter	Lichtstrom / Gesamt	Abstrahlwinkel	Energieeffizienz	Breite mm	Höhe mm
5 m set											
81-4008	6W	30W	warmweiß	3.000 K	40.000 h	240 lm	1.200 lm	120°	A+	8	16
81-4009	6W	30W	weiß	4.000 K	40.000 h	264 lm	1.220 lm	120°	A+	8	16
81-4010	6W	30W	rot	620 nm	40.000 h	--	--	120°	A+	8	16
81-4011	6W	30W	blau	470 nm	40.000 h	--	--	120°	A+	8	16
81-4012	6W	30W	grün	525 nm	40.000 h	--	--	120°	A+	8	16
10 m set											
81-4013	6W	60W	warmweiß	3.000 K	40.000 h	240 lm	2.400 lm	120°	A+	8	16
81-4014	6W	60W	weiß	4.000 K	40.000 h	264 lm	2.640 lm	120°	A+	8	16
81-4015	6W	60W	rot	620 nm	40.000 h	--	--	120°	A+	8	16
81-4016	6W	60W	blau	470 nm	40.000 h	--	--	120°	A+	8	16
81-4017	6W	60W	grün	525 nm	40.000 h	--	--	120°	A+	8	16

- Spannung 24V/DC



# LED FEUCHTRAUMLEUCHTEN IP65



Die M-Light Produktfamilie Feuchtraumleuchten umfasst 4 Leuchten Serien in 10 Leistungsstufen und mit zwei Lichtfarben. Die Leuchten erreichen einen Lichtstrom von bis zu 6.300 lm.

14 / 26 / 36 W, 1-flammig, 4000 / 6000 K / Standard



## PRODUKTFAMILIE



20 / 40 / 50 W, 4000 K / Linear



20 / 30 W, 4000 K

Die **Standardversionen** erhalten Sie in den Längen von 600 mm, 1.200 mm und 1.500 mm, die **Linearleuchten** in den Längen 650 mm, 1.250 mm und 1.550 mm.

29 / 59 / 70 W, 2-flammig, 4000 / 6000 K / Standard

## FEUCHTRAUM IK08





# LED FEUCHTRAUMLEUCHE

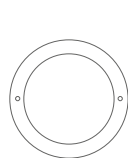
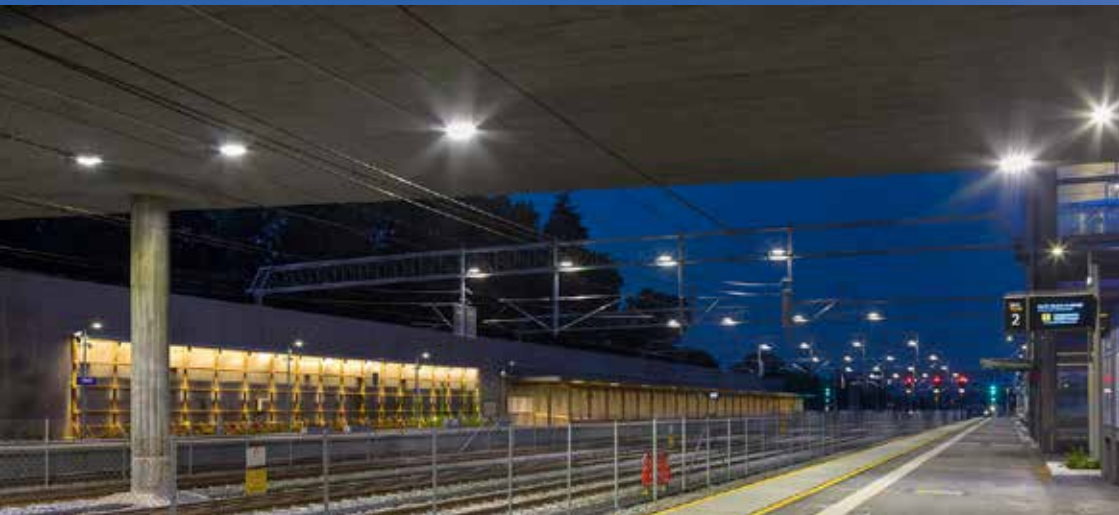

280 mm

81-3208

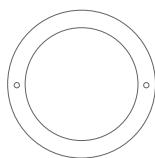

350 mm

81-3209

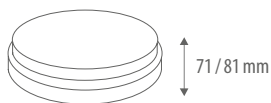

71 / 81 mm

Diese Leuchte enthält eingebaute LED. Diese LED können in der Leuchte nicht ausgetauscht werden.



Artikelnummer	Leistung	Spannung	Lichtfarbe	Farbtemperatur	mittlere Lebensdauer	Lichtstrom	Abstrahlwinkel	Energieeffizienz	Durchmesser mm	Höhe mm
81-3208	20W	230V	weiß	4.000 K	30.000 h	1.800lm	120°	A+	280	71
81-3209	30W	230V	weiß	4.000 K	30.000 h	2.800lm	120°	A+	350	81

- LED-Leuchte für Netzspannung 230V
- nicht dimmbar
- mittlere Lebensdauer: bis zu 30.000 h
- hohe Farbwiedergabe Ra >80
- Gehäuse und Abdeckung aus Polycarbonat (weiß, opal)
- IK 08



# LED FEUCHTRAUM-LINEARLEUCHE

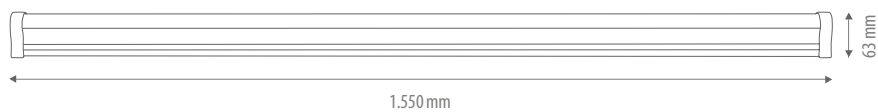
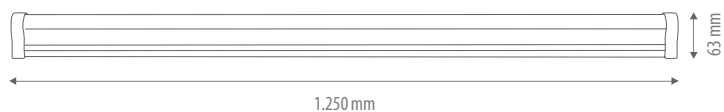
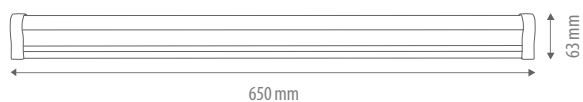

Diese Leuchte enthält eingebaute LED. Diese LED können in der Leuchte nicht ausgetauscht werden.



Artikelnummer	Leistung	Spannung	Lichtfarbe	Farbtemperatur	mittlere Lebensdauer	Lichtstrom	Ausgangs-Strom	Abstrahlwinkel	Energieeffizienz	L x B mm	Höhe mm
81-1320	20W	230V	weiß	4.000 K	30.000 h	1.800 lm	110 mA	120°	A+	650 x 63	75
81-1321	40W	230V	weiß	4.000 K	30.000 h	3.600 lm	280 mA	120°	A+	1.250 x 63	75
81-1322	50W	230V	weiß	4.000 K	30.000 h	5.500 lm	600 mA	120°	A+	1.550 x 63	75

- Gehäuse und Wanne aus Polycarbonat (nahtlos)
- Deckenbefestigung aus Edelstahl / Abpendelung möglich
- Kabeleinführung von beiden Seiten möglich, Kabelverschraubung inkl.
- Die Leuchten sind komplett geschlossen
- Anschlußboxen beidseitig
- Durchgangsverdrahtung 3-polig 1,5 mm<sup>2</sup>
- IK 08



# LED FEUCHTRAUM-WANNENLEUCHE



Artikelnummer	Leistung	Spannung	Lichtfarbe	Farbtemperatur	mittlere Lebensdauer	Lichtstrom	Ausgangstrom	Abstrahlwinkel	Energieeffizienz	Länge mm	Breite mm	Höhe mm
<b>1-flammig</b>												
81-1300	14 W	230 V	weiß	4.000 K	40.000 h	1.400 lm	140 mA	180°	A+	600	76	67
81-1301	14 W	230 V	kaltweiß	6.500 K	40.000 h	1.400 lm	140 mA	180°	A+	600	76	67
81-1304	28 W	230 V	weiß	4.000 K	40.000 h	2.800 lm	300 mA	180°	A+	1.200	76	67
81-1305	28 W	230 V	kaltweiß	6.500 K	40.000 h	2.800 lm	300 mA	180°	A+	1.200	76	67
81-1308	35 W	230 V	weiß	4.000 K	40.000 h	3.500 lm	300 mA	180°	A+	1.500	76	67
81-1309	35 W	230 V	kaltweiß	6.500 K	40.000 h	3.500 lm	300 mA	180°	A+	1.500	76	67



Beständigkeit siehe Seite: 148

Diese Leuchte enthält eingebaute LED. Diese LED können in der Leuchte nicht ausgetauscht werden.



Artikelnummer	Leistung	Spannung	Lichtfarbe	Farbtemperatur	mittlere Lebensdauer	Lichtstrom	Ausgangstrom	Abstrahlwinkel	Energieeffizienz	Länge mm	Breite mm	Höhe mm
<b>2-flammig</b>												
81-1302	28 W	230 V	weiß	4.000 K	40.000 h	2.800 lm	300 mA	180°	A+	600	99	70
81-1303	28 W	230 V	kaltweiß	6.500 K	40.000 h	2.800 lm	300 mA	180°	A+	600	99	70
81-1306	56 W	230 V	weiß	4.000 K	40.000 h	5.300 lm	300 mA	180°	A+	1.200	99	70
81-1307	56 W	230 V	kaltweiß	6.500 K	40.000 h	5.300 lm	300 mA	180°	A+	1.200	99	70
81-1310	70 W	230 V	weiß	4.000 K	40.000 h	6.300 lm	300 mA	180°	A+	1.500	99	70
81-1311	70 W	230 V	kaltweiß	6.500 K	40.000 h	6.300 lm	300 mA	180°	A+	1.500	99	70

- Gehäuse und Wanne aus Polycarbonat
- Deckenbefestigung aus Edelstahl / Abpendelung möglich
- Kabeleinführung von beiden Seiten möglich, Kabelverschraubung inkl.
- Auf der Rückseite befinden sich die Anschlussboxen
- Die Leuchten sind komplett geschlossen
- Durchgangsverdrahtung 3-polig 1,0 mm<sup>2</sup>
- IK 08



# LED HALLENLEUCHTEN HIGH BAY

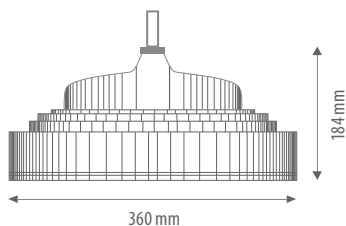
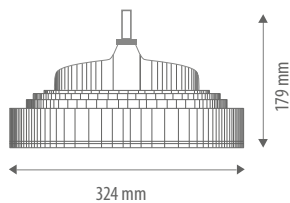

Diese Leuchte enthält eingebaute LED. Diese LED können in der Leuchte nicht ausgetauscht werden.





Artikelnummer	Leistung	Spannung	Lichtfarbe	Farbtemperatur	mittlere Lebensdauer	Lichtstrom	Ausgangs-Strom	Abstrahlwinkel	Energieeffizienz	Durchmesser mm	Höhe mm	Gewicht kg
81-3270	150 W	230 V	weiß	4.000 K	40.000 h	21.000 lm	3000 mA	120°	A+	324	179	4,2
81-3271	200 W	230 V	weiß	4.000 K	40.000 h	28.000 lm	4000 mA	120°	A+	360	184	5,0
89-1025	Deckenbügel für				150 W							
89-1026					200 W							

- empfohlen für hohe Decken, Warenlager, Logistikzentren und Industrie
- direkter Ersatz für Hallenleuchten mit Aluminiumreflektor und Metaldampfampfen oder Hochdruck-Quecksilberlampen
- Material:  
Aluminiumguss (Gehäuse)  
Polycarbonat (Abdeckung)





# LED AUßENWANDLEUCHE CUBE

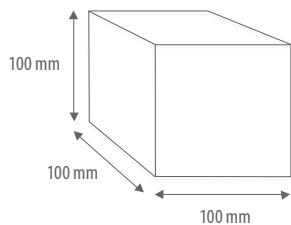

Diese Leuchte enthält eingebaute LED. Diese LED können in der Leuchte nicht ausgetauscht werden.



Lieferbar ab Januar 2019

Abstrahlwinkel oben / unten individuell einstellbar

Artikelnummer	Leistung	Spannung	Lichtfarbe	Farbtemperatur	mittlere Lebensdauer	Lichtstrom	Ausgangs-Strom	Abstrahlwinkel	Energieeffizienz	Maße L x B mm	Höhe mm
Gehäusefarbe: weiß											
81-4006	6 W	230 V	warmweiß	3.000 K	50.000 h	500 lm	300 mA	0-120°	A+	100 x 100	100
Gehäusefarbe: anthrazit											
81-4007	6 W	230 V	warmweiß	3.000 K	50.000 h	500 lm	300 mA	0-120°	A+	100 x 100	100

- inkl. Treiber, nicht dimmbar
- Aluminiumgehäuse
- hohe Farbwiedergabe Ra>80



# HAUSNUMMERNLEUCHE



Ausgestattet mit modernster LED-Technologie und hervorragend gestaltet, bekommen Sie eine herausragende Qualität. Hausnummern sind gesetzlich vorgeschrieben und bieten mit einer Beleuchtung zusätzliche Orientierung.

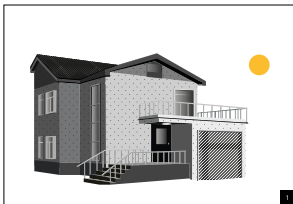

Das Licht schaltet sich automatisch bei Dämmerung an



Das Licht bleibt durch die Nacht eingeschaltet

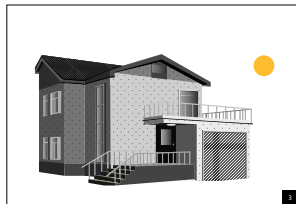

Das Licht schaltet sich bei Morgengrauen aus

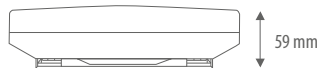
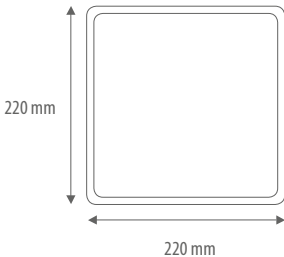

Diese Leuchte enthält eingebaute LED. Diese LED können in der Leuchte nicht ausgetauscht werden.



Artikelnummer	Leistung	Spannung	Lichtfarbe	Farbtemperatur	mittlere Lebensdauer	Lichtstrom	Ausgangs-Strom	Abstrahlwinkel	Energieeffizienz	Maße L x B mm	Höhe mm
81-4040	6 W	230 V	warmweiß	3.000 K	30.000 h	600 lm	80 mA	120°	A+	220 x 220	59

- Dämmerungsschalter fest eingestellt:  
ON:  $\leq 10$  lx OFF:  $\geq 80$  lx
- nicht dimmbar
- Gehäusefarbe: weiß
- Material: Polycarbonat
- IK 08



inkl. Klebesatz  
je 2 Zahlen



# LED OVALLEUCHE

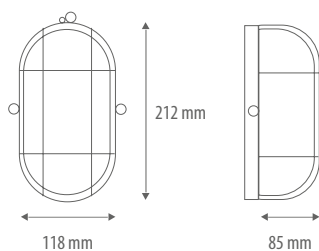

81-3201  
81-3200

Diese Leuchte enthält eingebaute LED. Diese LED können in der Leuchte nicht ausgetauscht werden.



Artikelnummer	Leistung	Spannung	Lichtfarbe	Farbtemperatur	mittlere Lebensdauer	Lichtstrom	Abstrahlwinkel	Energieeffizienz	Länge x Breite mm	Höhe mm
81-3200	7 W	230 V	weiß	4.000 K	40.000 h	700 lm	120°	A+	212 x 118	85
81-3201	9 W	230 V	weiß	4.000 K	40.000 h	900 lm	120°	A+	212 x 118	85

- LED-Leuchte für Netzspannung 230 V
- nicht dimmbar
- hohe Farbwiedergabe Ra >80
- Abdeckung aus Glas (Opal)
- Gehäuse aus Polycarbonat





# LED FLUTLICHTSTRAHLER





### Produkteigenschaften

- hohe Farbwiedergabe  $Ra > 80$
- geringer Energieverbrauch
- stoß- und vibrationsfest
- keine Aufwärmzeit, sofort 100 % Licht
- IP 65
- mit / ohne Netzzuleitung





# LED FLUTLICHTSTRAHLER



ohne Netzzuleitung

Artikelnummer	Leistung	Spannung	Lichtfarbe	Farbtemperatur	mittlere Lebensdauer	Lichtstrom	Ausgangs-Strom	Abstrahlwinkel	Energieeffizienz	Maße L x B mm	Höhe mm
<b>schwarz</b>											
81-3210	10 W	230 V	warmweiß	3.000 K	30.000 h	750 lm	45 mA	100°	A+	135 x 114	29
81-3214	10 W	230 V	kaltweiß	5.000 K	30.000 h	800 lm	45 mA	100°	A+	135 x 114	29
<b>weiß</b>											
81-3230	10 W	230 V	warmweiß	3.000 K	30.000 h	750 lm	45 mA	100°	A+	135 x 114	29
81-3234	10 W	230 V	kaltweiß	5.000 K	30.000 h	800 lm	45 mA	100°	A+	135 x 114	29

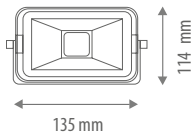

81-3210      81-3230

81-3214      81-3234



Diese Leuchte enthält eingebaute LED. Diese LED können in der Leuchte nicht ausgetauscht werden.



ohne Netzleitung

Artikelnummer	Leistung	Spannung	Lichtfarbe	Farbtemperatur	mittlere Lebensdauer	Lichtstrom	Ausgangs-Strom	Abstrahlwinkel	Energieeffizienz	Maße L x B mm	Höhe mm
<b>schwarz</b>											
81-3211	30 W	230 V	warmweiß	3.000 K	30.000 h	2.400 lm	130 mA	100°	A <sup>+</sup>	217 x 174	35
81-3215	30 W	230 V	kaltweiß	5.000 K	30.000 h	2.500 lm	130 mA	100°	A <sup>+</sup>	217 x 174	35
<b>weiß</b>											
81-3231	30 W	230 V	warmweiß	3.000 K	30.000 h	2.400 lm	130 mA	100°	A <sup>+</sup>	217 x 174	35
81-3235	30 W	230 V	kaltweiß	5.000 K	30.000 h	2.500 lm	130 mA	100°	A <sup>+</sup>	217 x 174	35

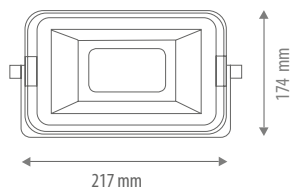

81-3211 81-3231  
81-3215 81-3235



# LED FLUTLICHTSTRAHLER



ohne Netzzuleitung

Artikelnummer	Leistung	Spannung	Lichtfarbe	Farbtemperatur	mittlere Lebensdauer	Lichtstrom	Ausgangs-Strom	Abstrahlwinkel	Energieeffizienz	Maße L x B mm	Höhe mm
<b>schwarz</b>											
81-3212	50 W	230 V	warmweiß	3.000 K	30.000 h	4.000 lm	220 mA	100°	A+	237 x 194	38
81-3216	50 W	230 V	kaltweiß	5.000 K	30.000 h	4.200 lm	220 mA	100°	A+	237 x 194	38

<b>weiß</b>											
81-3232	50 W	230 V	warmweiß	3.000 K	30.000 h	4.000 lm	220 mA	100°	A+	237 x 194	38
81-3236	50 W	230 V	kaltweiß	5.000 K	30.000 h	4.200 lm	220 mA	100°	A+	237 x 194	38

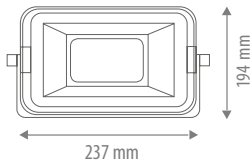

81-3212      81-3232

81-3216      81-3236



Diese Leuchte enthält eingebaute LED. Diese LED können in der Leuchte nicht ausgetauscht werden.



ohne Netzleitung

NEU  
NEU

Artikelnummer	Leistung	Spannung	Lichtfarbe	Farbtemperatur	mittlere Lebensdauer	Lichtstrom	Ausgangs-Strom	Abstrahlwinkel	Energieeffizienz	Maße L x B mm	Höhe mm
<b>schwarz</b>											
81-3213	100 W	230 V	warmweiß	3.000 K	30.000 h	8.000 lm	435 mA	100°	A <sup>+</sup>	293 x 232	41
81-3217	100 W	230 V	kaltweiß	5.000 K	30.000 h	8.300 lm	435 mA	100°	A <sup>+</sup>	293 x 232	41
81-3256	150 W	230 V	kaltweiß	5.000 K	30.000 h	12.000 lm	650 mA	100°	A <sup>+</sup>	404 x 320	52
81-3257	200 W	230 V	kaltweiß	5.000 K	30.000 h	16.000 lm	650 mA	100°	A <sup>+</sup>	404 x 320	52
<b>weiß</b>											
81-3233	100 W	230 V	warmweiß	3.000 K	30.000 h	8.000 lm	435 mA	100°	A <sup>+</sup>	293 x 232	41
81-3237	100 W	230 V	kaltweiß	5.000 K	30.000 h	8.300 lm	435 mA	100°	A <sup>+</sup>	293 x 232	41

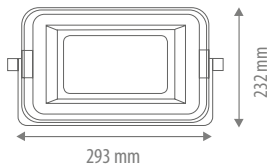

81-3213    81-3233  
81-3217    81-3237

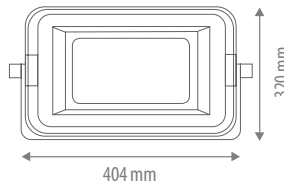

81-3256    81-3257



# LED FLUTLICHTSTRAHLER inkl. Netzzuleitung



mit 1,5 m Netzzuleitung / H05RNF 3 x 1mm<sup>2</sup>

Artikelnummer	Leistung	Spannung	Lichtfarbe	Farbtemperatur	mittlere Lebensdauer	Lichtstrom	Ausgangs-Strom	Abstrahlwinkel	Energieeffizienz	Maße L x B mm	Höhe mm
schwarz											
81-3260	10 W	230 V	warmweiß	3.000 K	30.000 h	750 lm	45 mA	100°	A+	135 x 114	29
81-3261	10 W	230 V	kaltweiß	5.000 K	30.000 h	800 lm	45 mA	100°	A+	135 x 114	29



mit 3 m Netzzuleitung / H05RNF 3 x 1mm<sup>2</sup>

Artikelnummer	Leistung	Spannung	Lichtfarbe	Farbtemperatur	mittlere Lebensdauer	Lichtstrom	Ausgangs-Strom	Abstrahlwinkel	Energieeffizienz	Maße L x B mm	Höhe mm
schwarz											
81-3262	30 W	230 V	warmweiß	3.000 K	30.000 h	2.400 lm	130 mA	100°	A+	217 x 174	35
81-3263	30 W	230 V	kaltweiß	5.000 K	30.000 h	2.500 lm	130 mA	100°	A+	217 x 174	35

Diese Leuchte enthält eingebaute LED. Diese LED können in der Leuchte nicht ausgetauscht werden.



mit 3 m Netzzuleitung / H05RNF 3 x 1mm<sup>2</sup>

Artikelnummer	Leistung	Spannung	Lichtfarbe	Farbtemperatur	mittlere Lebensdauer	Lichtstrom	Ausgangs-Strom	Abstrahlwinkel	Energieeffizienz	Maße L x B mm	Höhe mm
<b>schwarz</b>											
81-3264	50W	230V	warmweiß	3.000 K	30.000 h	4.000 lm	220 mA	100°	A <sup>+</sup>	237 x 194	38
81-3265	50W	230V	kaltweiß	5.000 K	30.000 h	4.200 lm	220 mA	100°	A <sup>+</sup>	237 x 194	38



mit 3 m Netzzuleitung / H05RNF 3 x 1mm<sup>2</sup>

Artikelnummer	Leistung	Spannung	Lichtfarbe	Farbtemperatur	mittlere Lebensdauer	Lichtstrom	Ausgangs-Strom	Abstrahlwinkel	Energieeffizienz	Maße L x B mm	Höhe mm
<b>schwarz</b>											
81-3266	100W	230V	warmweiß	3.000 K	30.000 h	8.000 lm	435 mA	100°	A <sup>+</sup>	293 x 232	41
81-3267	100W	230V	kaltweiß	5.000 K	30.000 h	8.300 lm	435 mA	100°	A <sup>+</sup>	293 x 232	41



# ZUBEHÖR FÜR FLUTLICHTSTRAHLER

89-1015 Dreibein-Stativ / Stahlrohr, lackiert



- Für 1 oder 2 Strahler
- Höhenverstellbar von 88 bis 218 cm
- Ausladung 48 cm (Traverse)
- Tragkraft: 20 kg

89-1016 Tragebügel / Stahlrohr, lackiert

- passend für alle Strahler
- Tragkraft: 10 kg
- Verwendung: Baustelle, Garten, Keller

Beispiel, Lieferung ohne Strahler



89-1017	Erdspeiß / Aluminium Druckguss
---------	--------------------------------



- passend für alle Strahler
- Maße: 210 x 40 mm
- Verwendung: Garten, Ausstellung

89-1018	Gummikabel (Verlängerung) Länge: 1,5 m
---------	--

89-1019	Gummikabel (Verlängerung) Länge: 3 m
---------	--------------------------------------



- Für alle Strahler
- Länge: 1,5 m
- Länge: 3 m
- Spezifikation H05 RNF 3 x 1 mm<sup>2</sup>

82-2000	Verbindungsmuffe IP68
---------	-----------------------



Zu Verbindung der Verlängerung mit der strahlerseitigen Anschlußleitung

- Spannung: 250 V max
- Strom: 10 A max.
- Schutzart: IP 68
- Kabeldurchmesser 9–12 mm



# ZUBEHÖR FÜR FLUTLICHTSTRAHLER

89-1020

Dreibein-Stativ / Komplettsset



- für 1 oder 2 Strahler
- Höhenverstellbar von 70 bis 160 cm
- Ausladung 48 cm (Traverse am Handstativ)
- Tragkraft: 20 kg

besteht aus:



Traverse mit Tragegriff  
(für 2/Strahler)



Schnellverschluß

Dreibein



Einzelfuß



Träger für Einzelstrahler

# LED FLUTLICHTSTRAHLER mit Sensor

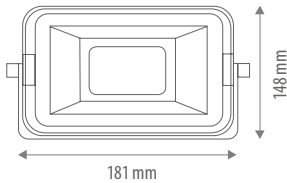

81-3218 81-3219 81-3238 81-3239

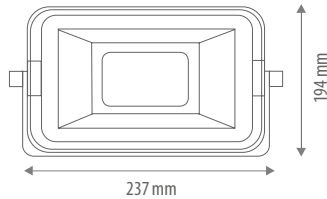

81-3220 81-3221 81-3250 81-3251

Sensor Erkennungsweite (< 24°C) 2 bis 8 m

Erkennungsradius: 120°

Temperaturbereich: -20°C bis +40°

Luftfeuchtigkeit: < 90 % RH

Umgebungshelligkeit: 5 bis 2000 Lux

Montagehöhe: 1,8 bis 2,5 m

Zeitverzögerung: 12s bis 6 min±



Diese Leuchte enthält eingebaute LED. Diese LED können in der Leuchte nicht ausgetauscht werden.



ohne Netzleitung

Artikelnummer	Leistung	Spannung	Lichtfarbe	Farbtemperatur	mittlere Lebensdauer	Lichtstrom	Ausgangs-Strom	Abstrahlwinkel	Energieeffizienz	Maße a x b mm	Höhe mm
<b>schwarz</b>											
81-3218	20 W	230 V	warmweiß	3.000 K	30.000 h	1.400 lm	87 mA	100°	A <sup>+</sup>	181 x 148	34
81-3219	20 W	230 V	kaltweiß	5.000 K	30.000 h	1.400 lm	87 mA	100°	A <sup>+</sup>	181 x 148	34
81-3220	50 W	230 V	warmweiß	3.000 K	30.000 h	4.000 lm	220 mA	100°	A <sup>+</sup>	237 x 194	38
81-3221	50 W	230 V	kaltweiß	5.000 K	30.000 h	4.200 lm	220 mA	100°	A <sup>+</sup>	237 x 194	38
<b>weiß</b>											
81-3238	20 W	230 V	warmweiß	3.000 K	30.000 h	1.400 lm	87 mA	100°	A <sup>+</sup>	181 x 148	34
81-3239	20 W	230 V	kaltweiß	5.000 K	30.000 h	1.400 lm	87 mA	100°	A <sup>+</sup>	181 x 148	34
81-3250	50 W	230 V	warmweiß	3.000 K	30.000 h	4.000 lm	220 mA	100°	A <sup>+</sup>	237 x 194	38
81-3251	50 W	230 V	kaltweiß	5.000 K	30.000 h	4.200 lm	220 mA	100°	A <sup>+</sup>	237 x 194	38



# LED-UNTERBAULEUCHE T5 / röhrenlos

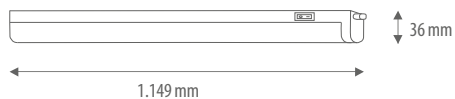
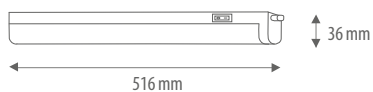
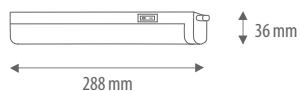

LED Unterbauleuchten werden hauptsächlich als Küchen- oder Regalbeleuchtung eingesetzt.

Die Montage erfolgt mittels Schraubclips.

Diese Leuchte enthält eingebaute LED. Diese LED können in der Leuchte nicht ausgetauscht werden.



Artikelnummer	Leistung	Spannung	Lichtfarbe	Farbtemperatur	mittlere Lebensdauer	Lichtstrom	Energieeffizienz	Länge mm	Breite mm	Höhe mm
83-1015	4W	230V	warmweiß	3.000 K	30.000 h	333 lm	A+	288	28,5	36
83-1016	7W	230V	warmweiß	3.000 K	30.000 h	656 lm	A+	516	28,5	36
83-1017	13W	230V	warmweiß	3.000 K	30.000 h	1.217 lm	A+	849	28,5	36
83-1018	18W	230V	warmweiß	3.000 K	30.000 h	1.870 lm	A+	1.149	28,5	36
83-1011	4W	230V	weiß	4.000 K	30.000 h	362 lm	A+	288	28,5	36
83-1012	7W	230V	weiß	4.000 K	30.000 h	700 lm	A+	516	28,5	36
83-1013	13W	230V	weiß	4.000 K	30.000 h	1.311 lm	A+	849	28,5	36
83-1014	18W	230V	weiß	4.000 K	30.000 h	1.956 lm	A+	1.149	28,5	36

- nicht dimmbar
- An- und Ausschalter
- Prismaabdeckung
- Befestigungsclips
- Netzleitung (1,8 m) und Verbindungskabel (15 cm)



# DALI - LED - TREIBER / Multi Current programmierbar

OUTPUT Current Setting						
	1	2	3	4	5	6
1400 mA	on	on	on	on	on	on
1300 mA	on	on	on	on	on	
1200 mA	on	on	on	on		
1050 mA	on	on	on			
900 mA	on	on				
800 mA	on					
700 mA						



DIM-Treiber für :

81-2040 / 81-2041 / 81-2042 / 81-2043 / 81-2044 / 81-2045 / 81-2046  
81-2064 / 81-2065



81-2040



81-2064



Artikelnummer	Leistung	Eingangsspannung	Ausgangstrom	Länge mm	Breite mm	Höhe mm	S-Klasse
81-9018	50 W	220V – 240V	700 – 1.400 mA	132	79	24	IP 20

- flackerfrei über den gesamten Dimmbereich (0 %–100 %)
- Primär dimmbar über Taster (Memory Funktion)
- Interne Dali Schnittstelle
- Sekundär dimmbar mit 1–10V Dimmer und Poti
- Unterstützt 10V PWM Dimmung (3kHz – 8kHz)
- Schutz gegen Kurzschluß, Überspannung und Überhitzung
- Stand-by Leistung: < 0,5 W





# LED-KONVERTER Konstantstrom 500 mA



- Ta - 20 – 35°C / Tc 60 °C
- geschützt gegen Kurzschluss
- Schutzklasse II gegen Stromschlag bei direktem und indirektem Kontakt
- Überspannungsschutz
- Wirkungsgrad 84 %
- dimmbar mit Phasenanschnittdimmer

Artikelnummer	Leistung	Eingangsspannung	Ausgangstrom	Länge mm	Breite mm	Höhe mm
81-9001	10 – 24 W	176 – 264 V	500 mA	117	40	31

DIM-Treiber für : 81-3096





- Ta - 40°C / Tc 65°C
- geschützt gegen Kurzschluss
- Schutzklasse II gegen Stromschlag bei direktem und indirektem Kontakt
- Überspannungsschutz
- Wirkungsgrad 93 %
- dimmbar mit Phasenanschnittdimmer

Artikelnummer	Leistung	Eingangsspannung	Ausgangstrom	Länge mm	Breite mm	Höhe mm
81-9013	11,5W	220 – 240V	350 mA	121	33	20

DIM-Treiber für:

81-3059 / 81-3060

81-3055 / 81-3056

81-3057 / 81-3058



81-3059



81-3056



81-3057



# LED-KONVERTER Konstantstrom 1,4 A



- Ta - 20 – 35°C / Tc 60 °C
- geschützt gegen Kurzschluss
- Schutzklasse II gegen Stromschlag bei direktem und indirektem Kontakt
- Überspannungsschutz
- Wirkungsgrad 91 %
- dimmbar mit 1–10V poti

Artikelnummer	Leistung	Eingangsspannung	Ausgangstrom	Länge mm	Breite mm	Höhe mm
81-9003	55 W	220 – 240V	1,4 A	192	40	33

DIM-Treiber für :



81-2004 / 81-2009 / 81-2014

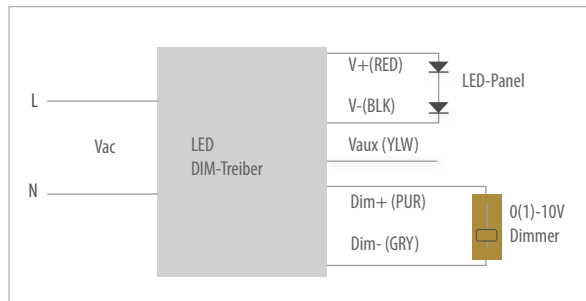



- Ta - 45°C / Tc 85 °C
- geschützt gegen Kurzschluss
- Schutzklasse II gegen Stromschlag bei direktem und indirektem Kontakt
- Überspannungsschutz
- Wirkungsgrad 90 %
- dimmbar mit 1–10V poti

Artikelnummer	Leistung	Eingangsspannung	Ausgangstrom	Länge mm	Breite mm	Höhe mm
81-9012	25 W – 44 W	100 V – 277 V	700 mA	147	44	30

DIM-Treiber für :

81-2040 / 81-2041 / 81-2042

81-2043 / 81-2044

81-2045 / 81-2046





10-1152



10-1153

Artikelnummer	Leistung	Eingangsspannung	Ausgangstrom	Frequenz	Länge mm	Breite mm	Höhe mm
10-1152	20 W	220–240 V	350 mA	50 Hz	145	50	22
10-1153	20 W	220–240 V	500 mA	50 Hz	145	50	22

- Ta - 20 – 35°C / Tc 60 °C
- geschützt gegen Kurzschluss
- Schutzklasse II gegen Stromschlag  
bei direktem und indirektem Kontakt
- Überspannungsschutz
- Wirkungsgrad 83 %



Artikelnummer	Leistung	Eingangsspannung	Ausgangstrom	Frequenz	Länge mm	Breite mm	Höhe mm
10-1155	6 W	220 – 240 V	350 mA	50 Hz	58	25	21

- Ta 50°C / Tc 60 °C
- geschützt gegen Kurzschluss
- Schutzklasse II gegen Stromschlag  
bei direktem und indirektem Kontakt
- Überspannungsschutz
- Wirkungsgrad 97 %

für:

81-3054 / 81-3055 / 81-3057

81-3060 / 81-3056 / 81-3058

