







































































































































Partida Madrigueres Sud 63A, Naves 1-4
03700 Dénia (Alicante) Spain
Tel: 965 753 083
info@kohl-lighting.com

www.kohl-lighting.com



























































ÍNDICE POR REFERENCIAS

REFERENCE INDEX

	K20123	46		K50317	39		K53101	36
	K50100	64		K50318	39		K53102	36
	K50110	61		K50400	44		K53105	37
	K50111	61		K50401	44		K53106	37
	K50112	62		K50405	40		K53107	37
	K50113	62		K50406	40		K53265	55
	K50125	66		K50407	40		K53266	55
	K50126	66		K50410	45		K53267	55
	K50130	63		K50411	45		K53270	50
	K50131	63		K50415	41		K53271	51
	K50132	64		K50416	41		K55001	80
	K50140	60		K50500	18		K55002	80
	K50141	60		K50501	22		K55003	80
	K50150	48		K50502	10		K55004	81
	K50151	48		K50503	12		K55006	81
	K50152	48		K50504	14		K55007	81
	K50200	30		K50505	16		K55008	80
	K50201	30		K50506	20		KAC50500	24
	K50202	30		K50600	42		KAC50501	24
	K50203	30		K50601	42		KAC50502	24
	K50206	30		K50700	54		KAC50503	24
	K50210	31		K50701	54		KAC50506	24
	K50211	31		K50710	56		KAC50150	49
	K50212	31		K50711	56		KAC50152	49
	K50220	32		K50712	56		KAC50300	53
	K50221	32		K50715	57		KAC50301	53
	K50222	33		K50716	57		KAC50302	53
	K50223	33		K50717	57		KAC50303	53
	K50224	33		K52100	74		KACFLEX1	84
	K50225	33		K52200	74		KACFLEX2	84
	K50226	33		K52300	75		KACRGB1	85
	K50230	34		K52301	75		KACRGB2	85
	K50231	34		K52400	70		KACRGB3	85
	K50232	34		K52401	70		KACRGB4	85
	K50233	34		K52500	72		KACRGB5	85
	K50300	52		K52501	72		KACRGBW1	85
	K50301	52		K52502	72		KD55100	84
	K50302	52		K52600	76		KD55101	84
	K50303	52		K52601	76		KDFLEX1	84
	K50310	38		K52602	76		KLB	67
	K50311	38		K52603	76		KP50001	82
	K50312	38		K52604	76		KP50002	82
	K50313	38		K52605	76		KP50003	82
	K50315	39		K53100	36		KP50004	82
	K50316	39						

ÍNDICE EN ORDEN ALFABÉTICO

ALPHABETIC ORDER INDEX

	BOLETUS	70		LIM ROUND	38
	CHESSE (595x595 mm)	18		LIM SQUARE	39
	CHESSE (1195x295 mm)	20		LUMIFLEX CC 28	80
	CHESSE (1195x595 mm)	22		LUXO	48
	CIRQUE	44		LUXO ACCESORIES	49
	CORNER	45		MAILBOX	74
	DAISY	64		MIRANDA	36
	DARA	52		MIRANDA SQUARE	37
	DARA ACCESORIES	53		MOON	61
	DASH	63		OZONE	62
	DAWN	60		PREMIUM	46
	DETEK	55		REBECCA	50
	DIP IP 65	62		REBECCA SQUARE	51
	DISC	30		SASHA	56
	DISC SQUARE	31		SAT ROUND	66
	DISC SQUARE SURFACE	34		SAT SQUARE	66
	DISC SURFACE	32		SERENA	57
	DOT	63		SHOWFLEX CV RGB ECO	81
	ELITE (595x595 mm)	14		SHOWFLEX CV RGBW	81
	ELITE (1195x595 mm)	16		STORM	76
	FLEX CC BLANCO DINÁMICO	81		SUN	60
	FLEX CV 15	80		TINA ROUND	40
	FLEX CV ECO	80		TINA SQUARE	41
	FLEX PRO CC 20	80		TINY ROUND	42
	FOCUS	64		TINY SQUARE	42
	HAMMER ROUND	75		TOWER	72
	HAMMER SQUARE	75		VENUS	61
	HUNTER	74		WINNER (595x595 mm)	10
	KLB	67		WINNER (1195x595 mm)	12
	LASSO	54			



PANEL LED / LED PANEL



LED INTEGRADO / INTEGRATED LED



GU10



EXTERIOR / OUTDOOR



TIRAS DE LED / LED STRIPS

PANEL LED / LED PANEL

10 WINNER
REF. K50502



12 WINNER
REF. K50503



14 ELITE
REF. K50504



16 ELITE
REF. K50505



18 CHESS
REF. K50500



20 CHESS
REF. K50506



22 CHESS
REF. K50501



**24 ACCESORIOS
ACCESSORIES**



LED INTEGRADO / INTEGRATED LED

30 DISC
REF. K50200/1/2/3/6



31 DISC SQUARE
REF. K50210/1/2



32 DISC SURFACE
REF. K50220/1/2/3/4/5/6



34 DISC SQUARE SURFACE
REF. K50230/1/2/3



36 MIRANDA
REF. K53100/1/2



37 MIRANDA SQUARE
REF. K53105/6/7



38 LIM ROUND
REF. K50310/1/2/3



39 LIM SQUARE
REF. K50315/6/7/8



40 TINA ROUND
REF. K50405/6/7



41 TINA SQUARE
REF. K50415/6



42 TINY ROUND
REF. K50600



43 TINY SQUARE
REF. K50601



44 CIRQUE
REF. K50400/1



45 CORNER
REF. K50410/1



46 PREMIUM
REF. K20123



48 LUXO
REF. K50150/1/2



50 REBECCA
REF. K53270



51 REBECCA SQUARE
REF. K53271



52 DARA
REF. K50300/1/2/3



54 LASSO
REF. K50700/1



55 DETEK
REF. K53265/6/7



56 SASHA
REF. K50710/1/2



57 SERENA
REF. K50715/6/7



GU10

60 SUN
REF. K50140



60 DAWN
REF. K50141



61 MOON
REF. K50110



61 VENUS
REF. K50111



62 OZONE
REF. K50112



62 DIP IP 65
REF. K50113



63 DOT
REF. K50130



63 DASH
REF. K50131



64 **DAISY**
REF. K50132



64 **FOCUS**
REF. K50100



66 **SAT ROUND**
REF. K50126



66 **SAT SQUARE**
REF. K50125



67 **KLB**



EXTERIOR / OUTDOOR

70 **BOLETUS**
REF. K52400/1



72 **TOWER**
REF. K52500/1/2



74 **MAILBOX**
REF. K52100



74 **HUNTER**
REF. K52200



75 **HAMMER ROUND**
REF. K52300



75 **HAMMER SQUARE**
REF. K52301



76 **STORM**
REF. K52600/1/2/3/4/5



TIRAS DE LED / LED STRIPS

80 **TIRAS DE LED**
LED STRIPS



82 **PERFILES**
PROFILES



84 **EQUIPOS**
DRIVERS



84 **REGULADORES**
DIMMERS



84 **ACCESORIOS**
ACCESSORIES



INFORMACIÓN TÉCNICA / TECHNICAL INFORMATION

88 **MEDIDAS DE CORTE / CUT OUT**

89 **SÍMBOLOS / SIMBOLS**

90 **FOTOMETRÍAS / PHOTOMETRICS**

92 **GRADO DE PROTECCIÓN IP / IP DEGREE OF PROTECTION**

93 **CLASES DE PROTECCIÓN CONTRA CHOQUES ELÉCTRICOS /
PROTECTION CLASSES AGAINST ELECTRIC SHOCKS**

94 **CONDICIONES DE GARANTÍA / WARRANTY CONDITIONS**

PANEL LED

**INTEGRATED
LED**

GU10

OUTDOOR

LED STRIPS

**TECHNICAL
INFORMATION**

WINNER

REF. K50502



○ Blanco / White **3000K**

K50502.W.OP.3K	3589 lm	OP	NO DIM	100,00 €
K50502.W.OP.3K.DA	3589 lm	OP	DALI	163,00 €
K50502.W.OP.3K.PU	3589 lm	OP	PUSH	163,00 €
K50502.W.OP.3K.D1	3589 lm	OP	1..10V	148,60 €
K50502.W.MP.3K	3441 lm	MP	NO DIM	112,00 €
K50502.W.MP.3K.DA	3441 lm	MP	DALI	175,00 €
K50502.W.MP.3K.PU	3441 lm	MP	PUSH	175,00 €
K50502.W.MP.3K.D1	3441 lm	MP	1..10V	160,60 €
K50502.W.SK.3K	2010 lm	SK	NO DIM	200,00 €
K50502.W.SK.3K.DA	2010 lm	SK	DALI	263,00 €
K50502.W.SK.3K.PU	2010 lm	SK	PUSH	263,00 €
K50502.W.SK.3K.D1	2010 lm	SK	1..10V	248,60 €

○ Blanco / White **4000K**

K50502.W.OP.4K	3885 lm	OP	NO DIM	100,00 €
K50502.W.OP.4K.DA	3885 lm	OP	DALI	163,00 €
K50502.W.OP.4K.PU	3885 lm	OP	PUSH	163,00 €
K50502.W.OP.4K.D1	3885 lm	OP	1..10V	148,60 €
K50502.W.MP.4K	3700 lm	MP	NO DIM	112,00 €
K50502.W.MP.4K.DA	3700 lm	MP	DALI	175,00 €
K50502.W.MP.4K.PU	3700 lm	MP	PUSH	175,00 €
K50502.W.MP.4K.D1	3700 lm	MP	1..10V	160,60 €
K50502.W.SK.4K	2176 lm	SK	NO DIM	200,00 €
K50502.W.SK.4K.DA	2176 lm	SK	DALI	263,00 €
K50502.W.SK.4K.PU	2176 lm	SK	PUSH	263,00 €
K50502.W.SK.4K.D1	2176 lm	SK	1..10V	248,60 €

○ Blanco / White **6000K**

K50502.W.OP.6K	4000 lm	OP	NO DIM	100,00 €
K50502.W.OP.6K.DA	4000 lm	OP	DALI	163,00 €
K50502.W.OP.6K.PU	4000 lm	OP	PUSH	163,00 €
K50502.W.OP.6K.D1	4000 lm	OP	1..10V	148,60 €
K50502.W.MP.6K	3774 lm	MP	NO DIM	112,00 €
K50502.W.MP.6K.DA	3774 lm	MP	DALI	175,00 €
K50502.W.MP.6K.PU	3774 lm	MP	PUSH	175,00 €
K50502.W.MP.6K.D1	3774 lm	MP	1..10V	160,60 €
K50502.W.SK.6K	2240 lm	SK	NO DIM	200,00 €
K50502.W.SK.6K.DA	2240 lm	SK	DALI	263,00 €
K50502.W.SK.6K.PU	2240 lm	SK	PUSH	263,00 €
K50502.W.SK.6K.D1	2240 lm	SK	1..10V	248,60 €

Medidas / Measures:

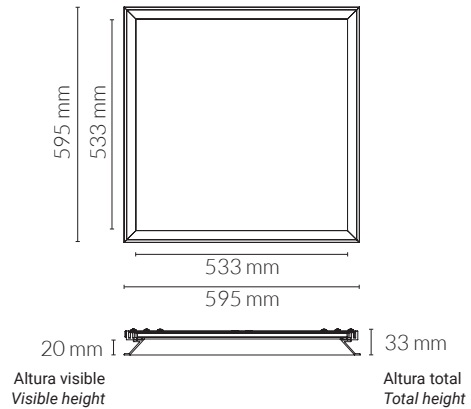

Opciones de difusor / Optic cover options:

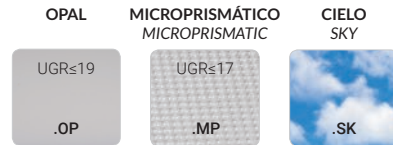

Opciones de acabado / Finish options:

Colores - Colors	
● Negro - Black	.BK
● Gris - Grey	.GY
● Azul - Blue	.BL
● Aqua - Aqua	.AQ
● Rojo - Red	.RE
● Rosa - Pink	.PI
● Flamenco - Flamingo	.FL
● Naranja - Orange	.OR
● Verde - Green	.GR
● Oro - Gold	.G

El color por defecto es blanco. En caso de querer otro, sustituir ".W" por la referencia del acabado deseado.
The default color is white. If you want another one, replace ".W" by desired color reference.



WINNER

REF. K50503



○ Blanco / White **3000K**

K50503.W.OP.3K	5616 lm	OP	NO DIM	205,00 €
K50503.W.OP.3K.DA	5616 lm	OP	DALI	331,00 €
K50503.W.OP.3K.PU	5616 lm	OP	PUSH	331,00 €
K50503.W.OP.3K.D1	5616 lm	OP	1..10V	301,90 €
K50503.W.MP.3K	5328 lm	MP	NO DIM	229,00 €
K50503.W.MP.3K.DA	5328 lm	MP	DALI	355,00 €
K50503.W.MP.3K.PU	5328 lm	MP	PUSH	355,00 €
K50503.W.MP.3K.D1	5328 lm	MP	1..10V	325,90 €
K50503.W.SK.3K	3145 lm	SK	NO DIM	345,00 €
K50503.W.SK.3K.DA	3145 lm	SK	DALI	471,00 €
K50503.W.SK.3K.PU	3145 lm	SK	PUSH	471,00 €
K50503.W.SK.3K.D1	3145 lm	SK	1..10V	441,90 €

○ Blanco / White **4000K**

K50503.W.OP.4K	6264 lm	OP	NO DIM	205,00 €
K50503.W.OP.4K.DA	6264 lm	OP	DALI	331,00 €
K50503.W.OP.4K.PU	6264 lm	OP	PUSH	331,00 €
K50503.W.OP.4K.D1	6264 lm	OP	1..10V	301,90 €
K50503.W.MP.4K	6048 lm	MP	NO DIM	229,00 €
K50503.W.MP.4K.DA	6048 lm	MP	DALI	355,00 €
K50503.W.MP.4K.PU	6048 lm	MP	PUSH	355,00 €
K50503.W.MP.4K.D1	6048 lm	MP	1..10V	325,90 €
K50503.W.SK.4K	3508 lm	SK	NO DIM	345,00 €
K50503.W.SK.4K.DA	3508 lm	SK	DALI	471,00 €
K50503.W.SK.4K.PU	3508 lm	SK	PUSH	471,00 €
K50503.W.SK.4K.D1	3508 lm	SK	1..10V	441,90 €

○ Blanco / White **6000K**

K50503.W.OP.6K	6494 lm	OP	NO DIM	205,00 €
K50503.W.OP.6K.DA	6494 lm	OP	DALI	331,00 €
K50503.W.OP.6K.PU	6494 lm	OP	PUSH	331,00 €
K50503.W.OP.6K.D1	6494 lm	OP	1..10V	301,90 €
K50503.W.MP.6K	6192 lm	MP	NO DIM	229,00 €
K50503.W.MP.6K.DA	6192 lm	MP	DALI	355,00 €
K50503.W.MP.6K.PU	6192 lm	MP	PUSH	355,00 €
K50503.W.MP.6K.D1	6192 lm	MP	1..10V	325,90 €
K50503.W.SK.6K	3637 lm	SK	NO DIM	345,00 €
K50503.W.SK.6K.DA	3637 lm	SK	DALI	471,00 €
K50503.W.SK.6K.PU	3637 lm	SK	PUSH	471,00 €
K50503.W.SK.6K.D1	3637 lm	SK	1..10V	441,90 €

Medidas / Measures:

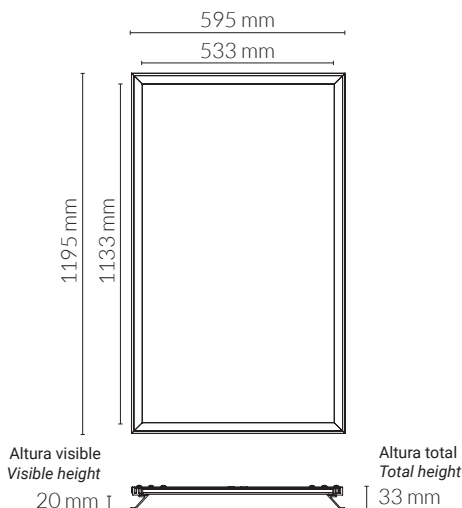

Opciones de difusor / Optic cover options:

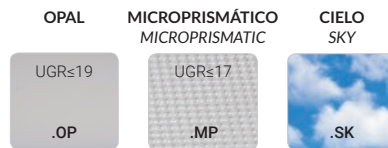

Opciones de acabado / Finish options:

Colores - Colors		
● Negro - Black	+ 34 €	.BK
● Gris - Grey	+ 34 €	.GY
● Azul - Blue	+ 34 €	.BL
● Aqua - Aqua	+ 34 €	.AQ
● Rojo - Red	+ 34 €	.RE
● Rosa - Pink	+ 34 €	.PI
● Flamenco - Flamingo	+ 34 €	.FL
● Naranja - Orange	+ 34 €	.OR
● Verde - Green	+ 34 €	.GR
● Oro - Gold	+ 39 €	.G

El color por defecto es blanco. En caso de querer otro, sustituir ".W" por la referencia del acabado deseado.
The default color is white. If you want another one, replace ".W" by desired color reference.

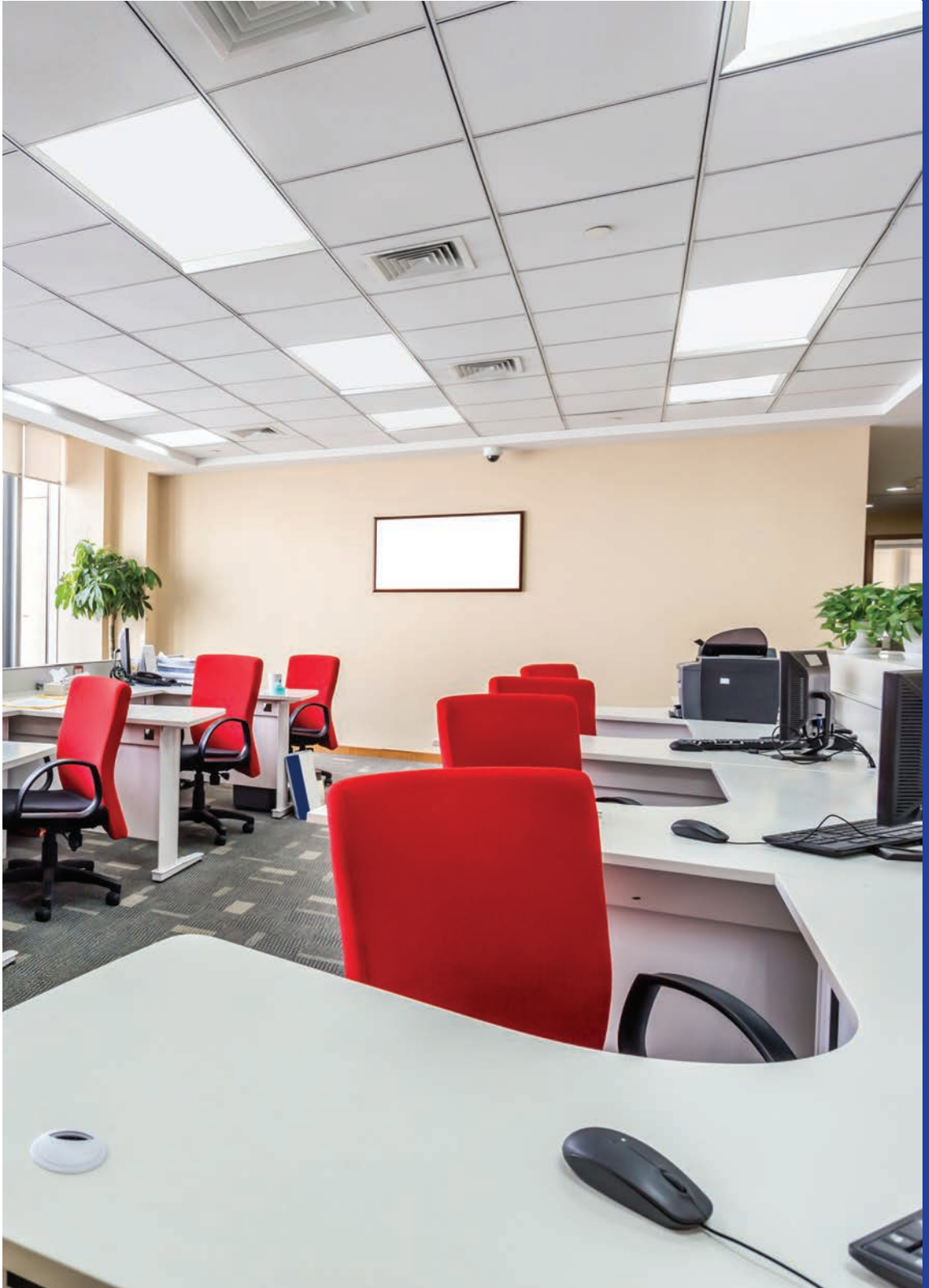

ELITE

REF. K50504



○ Blanco / White **3000K**

K50504.W.OP.3K	3589 lm	OP	NO DIM	100,00 €
K50504.W.OP.3K.DA	3589 lm	OP	DALI	163,00 €
K50504.W.OP.3K.PU	3589 lm	OP	PUSH	163,00 €
K50504.W.OP.3K.D1	3589 lm	OP	1..10V	148,60 €
K50504.W.MP.3K	3441 lm	MP	NO DIM	112,00 €
K50504.W.MP.3K.DA	3441 lm	MP	DALI	175,00 €
K50504.W.MP.3K.PU	3441 lm	MP	PUSH	175,00 €
K50504.W.MP.3K.D1	3441 lm	MP	1..10V	160,60 €
K50504.W.SK.3K	2010 lm	SK	NO DIM	200,00 €
K50504.W.SK.3K.DA	2010 lm	SK	DALI	263,00 €
K50504.W.SK.3K.PU	2010 lm	SK	PUSH	263,00 €
K50504.W.SK.3K.D1	2010 lm	SK	1..10V	248,60 €

○ Blanco / White **4000K**

K50504.W.OP.4K	3885 lm	OP	NO DIM	100,00 €
K50504.W.OP.4K.DA	3885 lm	OP	DALI	163,00 €
K50504.W.OP.4K.PU	3885 lm	OP	PUSH	163,00 €
K50504.W.OP.4K.D1	3885 lm	OP	1..10V	148,60 €
K50504.W.MP.4K	3700 lm	MP	NO DIM	112,00 €
K50504.W.MP.4K.DA	3700 lm	MP	DALI	175,00 €
K50504.W.MP.4K.PU	3700 lm	MP	PUSH	175,00 €
K50504.W.MP.4K.D1	3700 lm	MP	1..10V	160,60 €
K50504.W.SK.4K	2176 lm	SK	NO DIM	200,00 €
K50504.W.SK.4K.DA	2176 lm	SK	DALI	263,00 €
K50504.W.SK.4K.PU	2176 lm	SK	PUSH	263,00 €
K50504.W.SK.4K.D1	2176 lm	SK	1..10V	248,60 €

○ Blanco / White **6000K**

K50504.W.OP.6K	4000 lm	OP	NO DIM	100,00 €
K50504.W.OP.6K.DA	4000 lm	OP	DALI	163,00 €
K50504.W.OP.6K.PU	4000 lm	OP	PUSH	163,00 €
K50504.W.OP.6K.D1	4000 lm	OP	1..10V	148,60 €
K50504.W.MP.6K	3774 lm	MP	NO DIM	112,00 €
K50504.W.MP.6K.DA	3774 lm	MP	DALI	175,00 €
K50504.W.MP.6K.PU	3774 lm	MP	PUSH	175,00 €
K50504.W.MP.6K.D1	3774 lm	MP	1..10V	160,60 €
K50504.W.SK.6K	2240 lm	SK	NO DIM	200,00 €
K50504.W.SK.6K.DA	2240 lm	SK	DALI	263,00 €
K50504.W.SK.6K.PU	2240 lm	SK	PUSH	263,00 €
K50504.W.SK.6K.D1	2240 lm	SK	1..10V	248,60 €

Medidas / Measures:

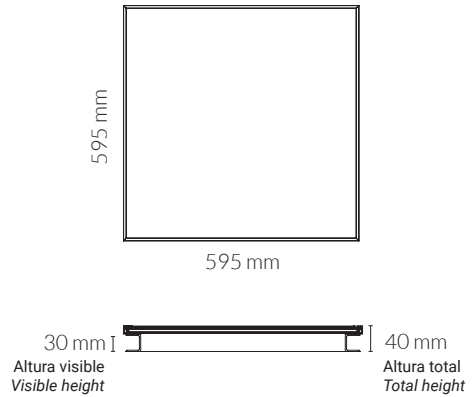

Opciones de difusor / Optic cover options:

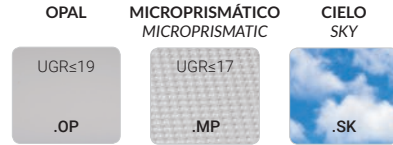

Opciones de acabado / Finish options:

Colores - Colors	
● Negro - Black	.BK
● Gris - Grey	.GY
● Azul - Blue	.BL
● Aqua - Aqua	.AQ
● Rojo - Red	.RE
● Rosa - Pink	.PI
● Flamenco - Flamingo	.FL
● Naranja - Orange	.OR
● Verde - Green	.GR
● Oro - Gold	.G

El color por defecto es blanco. En caso de querer otro, sustituir ".W" por la referencia del acabado deseado.
The default color is white. If you want another one, replace ".W" by desired color reference.



ELITE

REF. K50505

72W



900 mA

CRI ≥80

50000



5 YEARS WARRANTY

○ Blanco / White **3000K**

K50505.W.OP.3K	5616 lm	OP	NO DIM	205,00 €
K50505.W.OP.3K.DA	5616 lm	OP	DALI	331,00 €
K50505.W.OP.3K.PU	5616 lm	OP	PUSH	331,00 €
K50505.W.OP.3K.D1	5616 lm	OP	1..10V	301,90 €
K50505.W.MP.3K	5328 lm	MP	NO DIM	229,00 €
K50505.W.MP.3K.DA	5328 lm	MP	DALI	355,00 €
K50505.W.MP.3K.PU	5328 lm	MP	PUSH	355,00 €
K50505.W.MP.3K.D1	5328 lm	MP	1..10V	325,90 €
K50505.W.SK.3K	3145 lm	SK	NO DIM	345,00 €
K50505.W.SK.3K.DA	3145 lm	SK	DALI	471,00 €
K50505.W.SK.3K.PU	3145 lm	SK	PUSH	471,00 €
K50505.W.SK.3K.D1	3145 lm	SK	1..10V	441,90 €

○ Blanco / White **4000K**

K50505.W.OP.4K	6264 lm	OP	NO DIM	205,00 €
K50505.W.OP.4K.DA	6264 lm	OP	DALI	331,00 €
K50505.W.OP.4K.PU	6264 lm	OP	PUSH	331,00 €
K50505.W.OP.4K.D1	6264 lm	OP	1..10V	301,90 €
K50505.W.MP.4K	6048 lm	MP	NO DIM	229,00 €
K50505.W.MP.4K.DA	6048 lm	MP	DALI	355,00 €
K50505.W.MP.4K.PU	6048 lm	MP	PUSH	355,00 €
K50505.W.MP.4K.D1	6048 lm	MP	1..10V	325,90 €
K50505.W.SK.4K	3508 lm	SK	NO DIM	345,00 €
K50505.W.SK.4K.DA	3508 lm	SK	DALI	471,00 €
K50505.W.SK.4K.PU	3508 lm	SK	PUSH	471,00 €
K50505.W.SK.4K.D1	3508 lm	SK	1..10V	441,90 €

○ Blanco / White **6000K**

K50505.W.OP.6K	6494 lm	OP	NO DIM	205,00 €
K50505.W.OP.6K.DA	6494 lm	OP	DALI	331,00 €
K50505.W.OP.6K.PU	6494 lm	OP	PUSH	331,00 €
K50505.W.OP.6K.D1	6494 lm	OP	1..10V	301,90 €
K50505.W.MP.6K	6192 lm	MP	NO DIM	229,00 €
K50505.W.MP.6K.DA	6192 lm	MP	DALI	355,00 €
K50505.W.MP.6K.PU	6192 lm	MP	PUSH	355,00 €
K50505.W.MP.6K.D1	6192 lm	MP	1..10V	325,90 €
K50505.W.SK.6K	3637 lm	SK	NO DIM	345,00 €
K50505.W.SK.6K.DA	3637 lm	SK	DALI	471,00 €
K50505.W.SK.6K.PU	3637 lm	SK	PUSH	471,00 €
K50505.W.SK.6K.D1	3637 lm	SK	1..10V	441,90 €

Medidas / Measures:

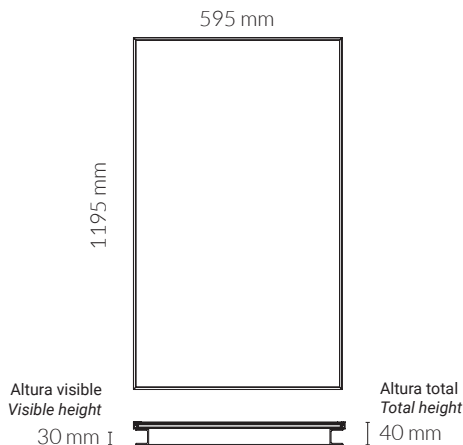

Opciones de difusor / Optic cover options:



Opciones de acabado / Finish options:

Colores - Colors	
	Negro - Black .BK
	Gris - Grey .GY
	Azul - Blue .BL
	Aqua - Aqua .AQ
	Rojo - Red .RE
	Rosa - Pink .PI
	Flamenco - Flamingo .FL
	Naranja - Orange .OR
	Verde - Green .GR
	Oro - Gold .G

El color por defecto es blanco. En caso de querer otro, sustituir ".W" por la referencia del acabado deseado.
The default color is white. If you want another one, replace ".W" by desired color reference.



CHESS

REF. K50500



○ Blanco / White **3000K**

K50500.W.OP.3K	3589 lm	OP	NO DIM	60,00 €
K50500.W.OP.3K.DA	3589 lm	OP	DALI	123,00 €
K50500.W.OP.3K.PU	3589 lm	OP	PUSH	123,00 €
K50500.W.OP.3K.D1	3589 lm	OP	1..10V	108,60 €
K50500.W.MP.3K	3441 lm	MP	NO DIM	72,00 €
K50500.W.MP.3K.DA	3441 lm	MP	DALI	135,00 €
K50500.W.MP.3K.PU	3441 lm	MP	PUSH	135,00 €
K50500.W.MP.3K.D1	3441 lm	MP	1..10V	120,60 €
K50500.W.SK.3K	2010 lm	SK	NO DIM	160,00 €
K50500.W.SK.3K.DA	2010 lm	SK	DALI	223,00 €
K50500.W.SK.3K.PU	2010 lm	SK	PUSH	223,00 €
K50500.W.SK.3K.D1	2010 lm	SK	1..10V	208,60 €

Medidas / Measures:

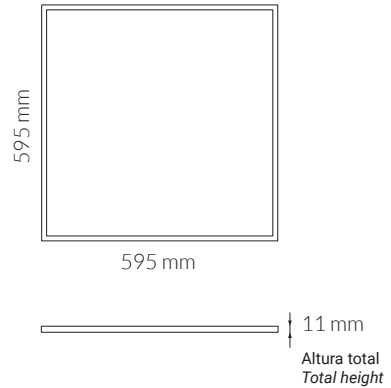

○ Blanco / White **4000K**

K50500.W.OP.4K	3885 lm	OP	NO DIM	60,00 €
K50500.W.OP.4K.DA	3885 lm	OP	DALI	123,00 €
K50500.W.OP.4K.PU	3885 lm	OP	PUSH	123,00 €
K50500.W.OP.4K.D1	3885 lm	OP	1..10V	108,60 €
K50500.W.MP.4K	3700 lm	MP	NO DIM	72,00 €
K50500.W.MP.4K.DA	3700 lm	MP	DALI	135,00 €
K50500.W.MP.4K.PU	3700 lm	MP	PUSH	135,00 €
K50500.W.MP.4K.D1	3700 lm	MP	1..10V	120,60 €
K50500.W.SK.4K	2176 lm	SK	NO DIM	160,00 €
K50500.W.SK.4K.DA	2176 lm	SK	DALI	223,00 €
K50500.W.SK.4K.PU	2176 lm	SK	PUSH	223,00 €
K50500.W.SK.4K.D1	2176 lm	SK	1..10V	208,60 €

Opciones de difusor / Optic cover options:

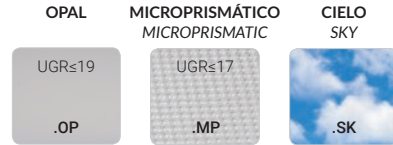

○ Blanco / White **6000K**

K50500.W.OP.6K	4000 lm	OP	NO DIM	60,00 €
K50500.W.OP.6K.DA	4000 lm	OP	DALI	123,00 €
K50500.W.OP.6K.PU	4000 lm	OP	PUSH	123,00 €
K50500.W.OP.6K.D1	4000 lm	OP	1..10V	108,60 €
K50500.W.MP.6K	3774 lm	MP	NO DIM	72,00 €
K50500.W.MP.6K.DA	3774 lm	MP	DALI	135,00 €
K50500.W.MP.6K.PU	3774 lm	MP	PUSH	135,00 €
K50500.W.MP.6K.D1	3774 lm	MP	1..10V	120,60 €
K50500.W.SK.6K	2240 lm	SK	NO DIM	160,00 €
K50500.W.SK.6K.DA	2240 lm	SK	DALI	223,00 €
K50500.W.SK.6K.PU	2240 lm	SK	PUSH	223,00 €
K50500.W.SK.6K.D1	2240 lm	SK	1..10V	208,60 €



CHESS

REF. K50506



○ Blanco / White **3000K**

K50506.W.OP.3K	3589 lm	OP	NO DIM	72,40 €
K50506.W.OP.3K.DA	3589 lm	OP	DALI	141,70 €
K50506.W.OP.3K.PU	3589 lm	OP	PUSH	141,70 €
K50506.W.OP.3K.D1	3589 lm	OP	1..10V	125,85 €
K50506.W.SK.3K	2153 lm	SK	NO DIM	182,40 €
K50506.W.SK.3K.DA	2153 lm	SK	DALI	251,70 €
K50506.W.SK.3K.PU	2153 lm	SK	PUSH	251,70 €
K50506.W.SK.3K.D1	2153 lm	SK	1..10V	235,85 €

○ Blanco / White **4000K**

K50506.W.OP.4K	3885 lm	OP	NO DIM	72,40 €
K50506.W.OP.4K.DA	3885 lm	OP	DALI	141,70 €
K50506.W.OP.4K.PU	3885 lm	OP	PUSH	141,70 €
K50506.W.OP.4K.D1	3885 lm	OP	1..10V	125,85 €
K50506.W.SK.4K	2331 lm	SK	NO DIM	182,40 €
K50506.W.SK.4K.DA	2331 lm	SK	DALI	251,70 €
K50506.W.SK.4K.PU	2331 lm	SK	PUSH	251,70 €
K50506.W.SK.4K.D1	2331 lm	SK	1..10V	235,85 €

○ Blanco / White **6000K**

K50506.W.OP.6K	4000 lm	OP	NO DIM	72,40 €
K50506.W.OP.6K.DA	4000 lm	OP	DALI	141,70 €
K50506.W.OP.6K.PU	4000 lm	OP	PUSH	141,70 €
K50506.W.OP.6K.D1	4000 lm	OP	1..10V	125,85 €
K50506.W.SK.6K	2400 lm	SK	NO DIM	182,40 €
K50506.W.SK.6K.DA	2400 lm	SK	DALI	251,70 €
K50506.W.SK.6K.PU	2400 lm	SK	PUSH	251,70 €
K50506.W.SK.6K.D1	2400 lm	SK	1..10V	235,85 €

Medidas / Measures:

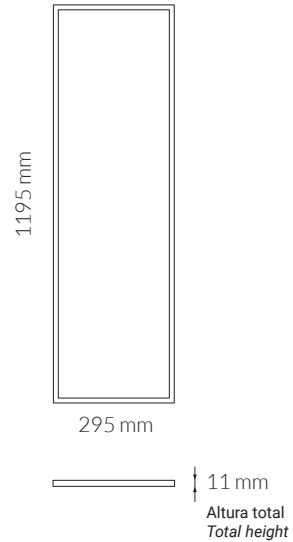

Opciones de difusor / Optic cover options:





CHESS

REF. K50501



○ Blanco / White **3000K**

K50501.W.OP.3K	5616 lm	OP	NO DIM	135,00 €
K50501.W.OP.3K.DA	5616 lm	OP	DALI	261,00 €
K50501.W.OP.3K.PU	5616 lm	OP	PUSH	261,00 €
K50501.W.OP.3K.D1	5616 lm	OP	1..10V	231,90 €
K50501.W.MP.3K	5328 lm	MP	NO DIM	159,00 €
K50501.W.MP.3K.DA	5328 lm	MP	DALI	285,00 €
K50501.W.MP.3K.PU	5328 lm	MP	PUSH	285,00 €
K50501.W.MP.3K.D1	5328 lm	MP	1..10V	255,90 €
K50501.W.SK.3K	3145 lm	SK	NO DIM	275,00 €
K50501.W.SK.3K.DA	3145 lm	SK	DALI	401,00 €
K50501.W.SK.3K.PU	3145 lm	SK	PUSH	401,00 €
K50501.W.SK.3K.D1	3145 lm	SK	1..10V	371,90 €

○ Blanco / White **4000K**

K50501.W.OP.4K	6264 lm	OP	NO DIM	135,00 €
K50501.W.OP.4K.DA	6264 lm	OP	DALI	261,00 €
K50501.W.OP.4K.PU	6264 lm	OP	PUSH	261,00 €
K50501.W.OP.4K.D1	6264 lm	OP	1..10V	231,90 €
K50501.W.MP.4K	6048 lm	MP	NO DIM	159,00 €
K50501.W.MP.4K.DA	6048 lm	MP	DALI	285,00 €
K50501.W.MP.4K.PU	6048 lm	MP	PUSH	285,00 €
K50501.W.MP.4K.D1	6048 lm	MP	1..10V	255,90 €
K50501.W.SK.4K	3508 lm	SK	NO DIM	275,00 €
K50501.W.SK.4K.DA	3508 lm	SK	DALI	401,00 €
K50501.W.SK.4K.PU	3508 lm	SK	PUSH	401,00 €
K50501.W.SK.4K.D1	3508 lm	SK	1..10V	371,90 €

○ Blanco / White **6000K**

K50501.W.OP.6K	6494 lm	OP	NO DIM	135,00 €
K50501.W.OP.6K.DA	6494 lm	OP	DALI	261,00 €
K50501.W.OP.6K.PU	6494 lm	OP	PUSH	261,00 €
K50501.W.OP.6K.D1	6494 lm	OP	1..10V	231,90 €
K50501.W.MP.6K	6192 lm	MP	NO DIM	159,00 €
K50501.W.MP.6K.DA	6192 lm	MP	DALI	285,00 €
K50501.W.MP.6K.PU	6192 lm	MP	PUSH	285,00 €
K50501.W.MP.6K.D1	6192 lm	MP	1..10V	255,90 €
K50501.W.SK.6K	3637 lm	SK	NO DIM	275,00 €
K50501.W.SK.6K.DA	3637 lm	SK	DALI	401,00 €
K50501.W.SK.6K.PU	3637 lm	SK	PUSH	401,00 €
K50501.W.SK.6K.D1	3637 lm	SK	1..10V	371,90 €

Medidas / Measures:

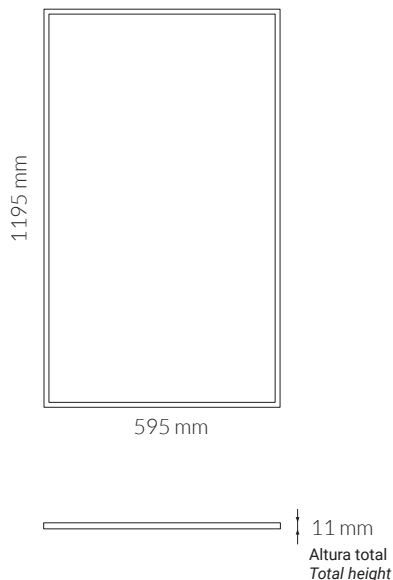

Opciones de difusor / Optic cover options:

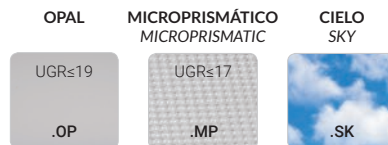



ACCESORIOS PARA TECHOS NO MODULARES

NON-MODULAR CEILING ACCESSORIES

Accesorios para WINNER, ELITE y CHESS / Accessories for WINNER, ELITE & CHESS:

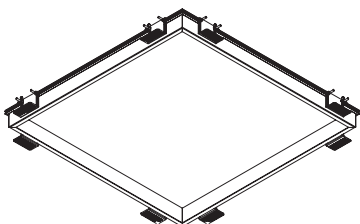

EMPOTRADO SIN MARCO - TRIMLESS		
KAC50502.TR	595x595 mm	93,50 €
KAC50503.TR	1195x595 mm	187,00 €
KAC50506.TR	1195x295 mm	156,20 €

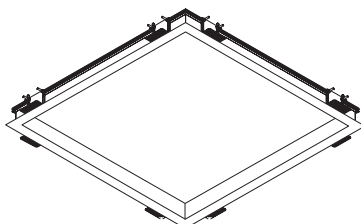

EMPOTRADO CON MARCO - RECESSED WITH FRAME		
KAC50502.RF	595x595 mm	89,54 €
KAC50503.RF	1195x595 mm	179,08 €
KAC50506.RF	1195x295 mm	148,50 €

Accesorios sólo para CHESS / Accessories just for CHESS:

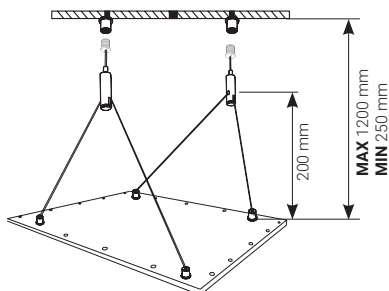

COLGANTE - PENDANT		
KAC50500.PN	595x595 mm	13,00 €
KAC50501.PN	1195x595 mm 1195x295 mm	15,00 €

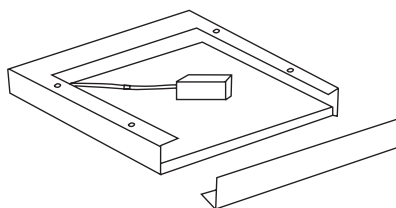

SUPERFICIE - SURFACE		
KAC50500.SR	595x595 mm	25,00 €
KAC50501.SR	1195x595 mm	36,00 €
KAC50506.SR	1195x295 mm	30,00 €



PINZAS PARA EMPOTRAR CLAMPS FOR RECESSING			
KAC50500.RF	595x595 mm	4 unidades/units	8,80 €
KAC50501.RF	1195x595 mm 1195x295 mm	6 unidades/units	10,00 €

COLORES COLORS

Codificación de colores para WINNER y ELITE / *Colors code for WINNER & ELITE:*

Verde / Green RAL 6018 .GR	Naranja / Orange RAL 2004 .OR	Negro / Black RAL 9005 .BK
Aqua / Aqua RAL 5021 .AQ	Rojo / Red RAL 3000 .RE	Gris / Grey RAL 9006 .GY
Azul / Blue RAL 5022 .BL	Flamenco / Flamingo RAL 3018 .FL	Blanco / White RAL 9003 .W
Oro / Gold SG 25 .G	Rosa / Pink RAL 3014 .PI	

FOTOGRAFÍAS ACCESORIOS CHESS CHESS ACCESSORIES PICTURES

Pinzas para empotrar el CHESS
Clamps for recessing CHESS



Accesorio para poner el CHESS en superficie
Accessory for attaching CHESS on surface

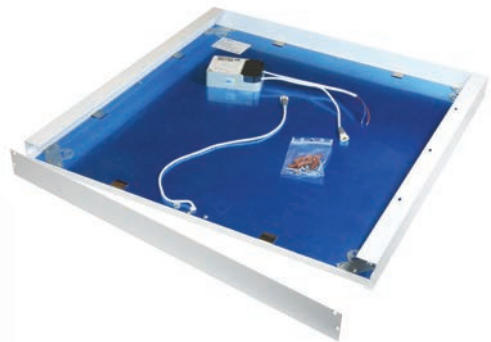

Accesorio para hacer colgante el CHESS
Accessory for converting CHESS in pendant

PANEL CONTROLADOR DE CAMBIO DE TEMPERATURA DE COLOR

REMOTE CONTROL BOARD FOR COLOUR TEMPERATURE CHANGE



Blanco dinámico/ *Dinamic white*

2900K - 5900K

3000K
Blanco cálido
Warm white
3399 lm

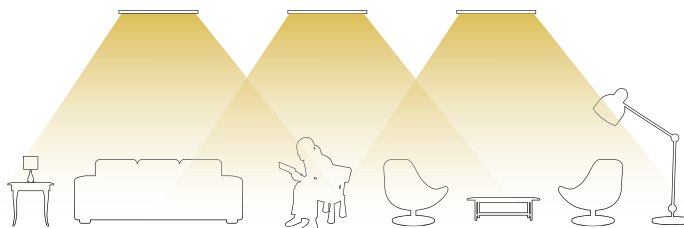

4000K
Blanco natural
Natural white
4202 lm



6000K
Blanco frío
Cool white
3655 lm



MANDO A DISTANCIA
REMOTE CONTROL

WINNER	K50502.W.OP.WT	40W · OPAL · 2900K-5900K · 585x585 mm	240,80 €
	K50503.W.OP.WT	55W · OPAL · 2900K-5900K · 1195x585 mm	360,40 €
ELITE	K50504.W.OP.WT	40W · OPAL · 2900K-5900K · 595x595 mm	240,80 €
	K50505.W.OP.WT	55W · OPAL · 2900K-5900K · 1195x595 mm	360,40 €
CHESS	K50500.W.OP.WT	40W · OPAL · 2900K-5900K · 595x595 mm	200,80 €
	K50501.W.OP.WT	55W · OPAL · 2900K-5900K · 1195x595 mm	290,40 €

3000K



4000K



6000K



PANEL LED

**INTEGRATED
LED**

GU10

OUTDOOR

LED STRIPS

TECHNICAL



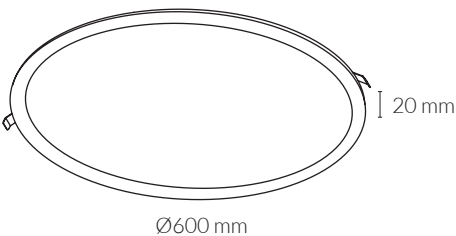
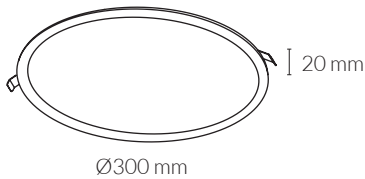
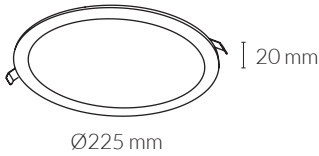
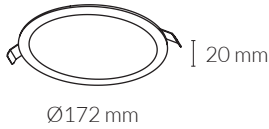
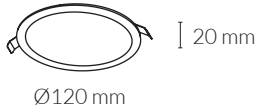

INFORMATION

DISC





REF. K50200/1/2/3/6



8W 300mA Ø108mm

	K50200.W.3K	360 lm	3000K	Blanco/White	11,30 €
	K50200.W.4K	464 lm	4000K	Blanco/White	11,30 €
	K50200.GY.3K	360 lm	3000K	Gris/Grey	11,30 €
	K50200.GY.4K	464 lm	4000K	Gris/Grey	11,30 €

12W 300mA Ø152mm

	K50201.W.3K	768 lm	3000K	Blanco/White	12,90 €
	K50201.W.4K	780 lm	4000K	Blanco/White	12,90 €
	K50201.GY.3K	768 lm	3000K	Gris/Grey	12,90 €
	K50201.GY.4K	780 lm	4000K	Gris/Grey	12,90 €

20W 300mA Ø205mm

	K50202.W.3K	1500 lm	3000K	Blanco/White	18,50 €
	K50202.W.4K	1560 lm	4000K	Blanco/White	18,50 €
	K50202.GY.3K	1500 lm	3000K	Gris/Grey	18,50 €
	K50202.GY.4K	1560 lm	4000K	Gris/Grey	18,50 €

24W 300mA Ø280mm

	K50203.W.3K	1800 lm	3000K	Blanco/White	23,00 €
	K50203.W.4K	1872 lm	4000K	Blanco/White	23,00 €
	K50203.GY.3K	1800 lm	3000K	Gris/Grey	23,00 €
	K50203.GY.4K	1872 lm	4000K	Gris/Grey	23,00 €

56W 900mA Ø580mm

	K50206.W.3K	3976 lm	3000K	Blanco/White	98,35 €
	K50206.W.4K	4032 lm	4000K	Blanco/White	98,35 €
	K50206.GY.3K	3976 lm	3000K	Gris/Grey	98,35 €
	K50206.GY.4K	4032 lm	4000K	Gris/Grey	98,35 €

DISC SQUARE

REF. K50210/1/2

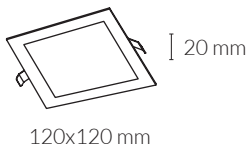

8W 300mA 100x100mm

	K50210.W.3K	360 lm	3000K	Blanco/White	11,30 €
	K50210.W.4K	464 lm	4000K	Blanco/White	11,30 €
	K50210.GY.3K	360 lm	3000K	Gris/Grey	11,30 €
	K50210.GY.4K	464 lm	4000K	Gris/Grey	11,30 €

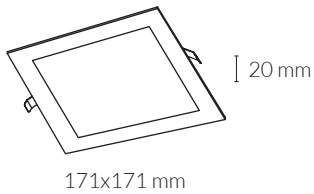

12W 300mA 155x155mm

	K50211.W.3K	768 lm	3000K	Blanco/White	12,85 €
	K50211.W.4K	780 lm	4000K	Blanco/White	12,85 €
	K50211.GY.3K	768 lm	3000K	Gris/Grey	12,85 €
	K50211.GY.4K	780 lm	4000K	Gris/Grey	12,85 €

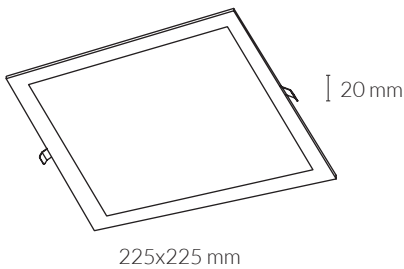

20W 300mA 200x200mm

	K50212.W.3K	1500 lm	3000K	Blanco/White	18,35 €
	K50212.W.4K	1560 lm	4000K	Blanco/White	18,35 €
	K50212.GY.3K	1500 lm	3000K	Gris/Grey	18,35 €
	K50212.GY.4K	1560 lm	4000K	Gris/Grey	18,35 €

DISC SURFACE

REF. K50220/1/2/3/4/5/6



8W 300mA

○	K50220.W.3K	360 lm	3000K	Blanco/White	13,95 €
○	K50220.W.4K	464 lm	4000K	Blanco/White	13,95 €
●	K50220.GY.3K	360 lm	3000K	Gris/Grey	13,95 €
●	K50220.GY.4K	464 lm	4000K	Gris/Grey	13,95 €

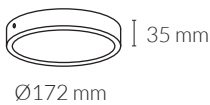

12W 300mA

○	K50221.W.3K	768 lm	3000K	Blanco/White	16,80 €
○	K50221.W.4K	780 lm	4000K	Blanco/White	16,80 €
●	K50221.GY.3K	768 lm	3000K	Gris/Grey	16,80 €
●	K50221.GY.4K	780 lm	4000K	Gris/Grey	16,80 €



20W 300mA

○	K50222.W.3K	1500 lm	3000K	Blanco/White	24,45 €
○	K50222.W.4K	1560 lm	4000K	Blanco/White	24,45 €
●	K50222.GY.3K	1500 lm	3000K	Gris/Grey	24,45 €
●	K50222.GY.4K	1560 lm	4000K	Gris/Grey	24,45 €

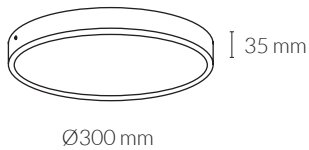

24W 300mA

○	K50223.W.3K	1800 lm	3000K	Blanco/White	29,60 €
○	K50223.W.4K	1872 lm	4000K	Blanco/White	29,60 €
●	K50223.GY.3K	1800 lm	3000K	Gris/Grey	29,60 €
●	K50223.GY.4K	1872 lm	4000K	Gris/Grey	29,60 €

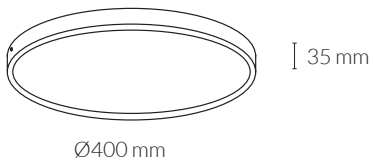

36W 700mA

○	K50224.W.3K	2700 lm	3000K	Blanco/White	56,80 €
○	K50224.W.4K	2808 lm	4000K	Blanco/White	56,80 €
●	K50224.GY.3K	2700 lm	3000K	Gris/Grey	56,80 €
●	K50224.GY.4K	2808 lm	4000K	Gris/Grey	56,80 €

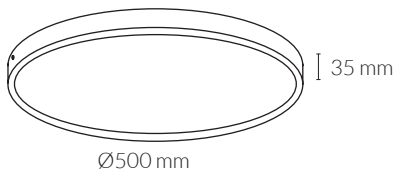

48W 1200mA

○	K50225.W.3K	3552 lm	3000K	Blanco/White	86,15 €
○	K50225.W.4K	3600 lm	4000K	Blanco/White	86,15 €
●	K50225.GY.3K	3552 lm	3000K	Gris/Grey	86,15 €
●	K50225.GY.4K	3600 lm	4000K	Gris/Grey	86,15 €

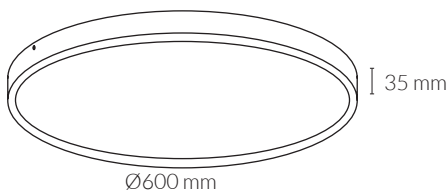

56W 900mA

○	K50226.W.3K	3976 lm	3000K	Blanco/White	102,60 €
○	K50226.W.4K	4032 lm	4000K	Blanco/White	102,60 €
●	K50226.GY.3K	3976 lm	3000K	Gris/Grey	102,60 €
●	K50226.GY.4K	4032 lm	4000K	Gris/Grey	102,60 €

DISC SQUARE SURFACE

REF. K50230/1/2/3

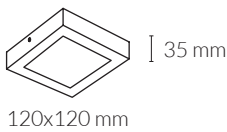

8W 300mA

○	K50230.W.3K	360 lm	3000K	Blanco/White	13,95 €
○	K50230.W.4K	464 lm	4000K	Blanco/White	13,95 €
●	K50230.GY.3K	360 lm	3000K	Gris/Grey	13,95 €
●	K50230.GY.4K	464 lm	4000K	Gris/Grey	13,95 €

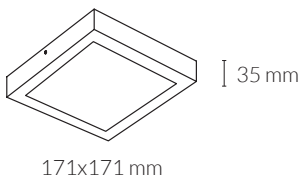

12W 300mA

○	K50231.W.3K	768 lm	3000K	Blanco/White	16,80 €
○	K50231.W.4K	780 lm	4000K	Blanco/White	16,80 €
●	K50231.GY.3K	768 lm	3000K	Gris/Grey	16,80 €
●	K50231.GY.4K	780 lm	4000K	Gris/Grey	16,80 €

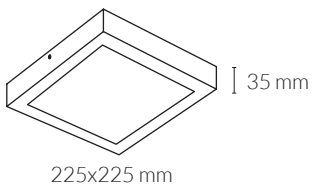

20W 300mA

○	K50232.W.3K	1500 lm	3000K	Blanco/White	24,50 €
○	K50232.W.4K	1560 lm	4000K	Blanco/White	24,50 €
●	K50232.GY.3K	1500 lm	3000K	Gris/Grey	24,50 €
●	K50232.GY.4K	1560 lm	4000K	Gris/Grey	24,50 €

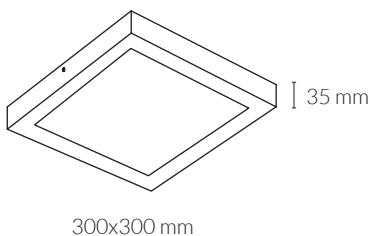

24W 300mA

○	K50233.W.3K	1800 lm	3000K	Blanco/White	29,60 €
○	K50233.W.4K	1872 lm	4000K	Blanco/White	29,60 €
●	K50233.GY.3K	1800 lm	3000K	Gris/Grey	29,60 €
●	K50233.GY.4K	1872 lm	4000K	Gris/Grey	29,60 €



MIRANDA

REF. K53100/1/2



NEW

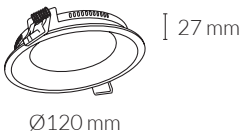

8W 200mA Ø109mm

<input type="radio"/>	K53100.W.3K	720 lm	3000K	Blanco/White	22,00 €
<input type="radio"/>	K53100.W.4K	800 lm	4000K	Blanco/White	22,00 €

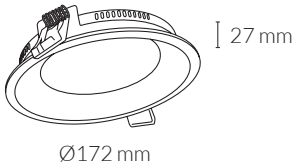

15W 350mA Ø159mm

<input type="radio"/>	K53101.W.3K	1350 lm	3000K	Blanco/White	35,00 €
<input type="radio"/>	K53101.W.4K	1500 lm	4000K	Blanco/White	35,00 €

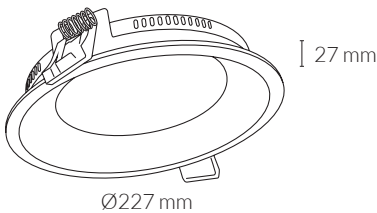

22W 600mA Ø214mm

<input type="radio"/>	K53102.W.3K	1980 lm	3000K	Blanco/White	48,00 €
<input type="radio"/>	K53102.W.4K	2200 lm	4000K	Blanco/White	48,00 €

MIRANDA SQUARE

REF. K53105/6/7



NEW

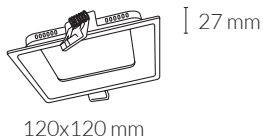

8W 200mA  109x109mm

<input type="radio"/>	K53105.W.3K	720 lm	3000K	Blanco/White	22,00 €
<input type="radio"/>	K53105.W.4K	800 lm	4000K	Blanco/White	22,00 €

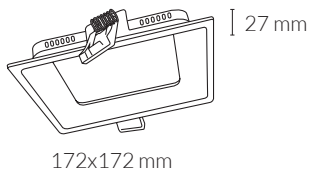

15W 350mA  159x159mm

<input type="radio"/>	K53106.W.3K	1350 lm	3000K	Blanco/White	35,00 €
<input type="radio"/>	K53106.W.4K	1500 lm	4000K	Blanco/White	35,00 €

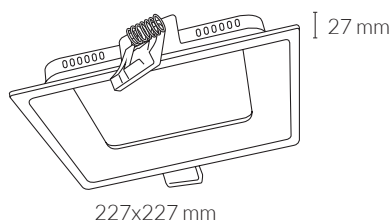

22W 600mA  214x214mm

<input type="radio"/>	K53107.W.3K	1980 lm	3000K	Blanco/White	48,00 €
<input type="radio"/>	K53107.W.4K	2200 lm	4000K	Blanco/White	48,00 €

LIM ROUND

REF. K50310/1/2/3

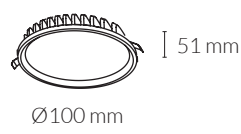

7W 350mA Ø86mm

○	K50310.W.3K	560 lm	3000K	Blanco/White	21,60 €
○	K50310.W.4K	581 lm	4000K	Blanco/White	21,60 €

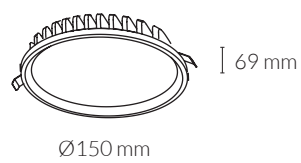

12W 350mA Ø136mm

○	K50311.W.3K	960 lm	3000K	Blanco/White	28,00 €
○	K50311.W.4K	996 lm	4000K	Blanco/White	28,00 €

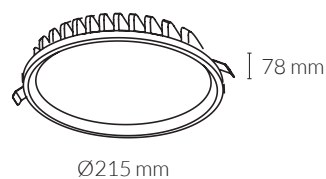

25W 700mA Ø201mm

○	K50312.W.3K	2000 lm	3000K	Blanco/White	51,45 €
○	K50312.W.4K	2075 lm	4000K	Blanco/White	51,45 €

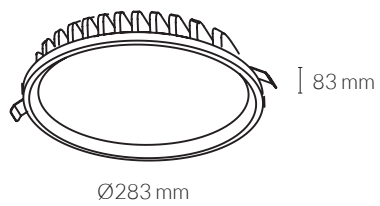

35W 900mA Ø266mm

○	K50313.W.3K	2800 lm	3000K	Blanco/White	88,00 €
○	K50313.W.4K	2905 lm	4000K	Blanco/White	88,00 €

LIM SQUARE

REF. K50315/6/7/8

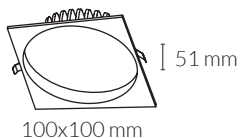

7W 350mA Ø86mm

○	K50315.W.3K	560 lm	3000K	Blanco/White	21,60 €
○	K50315.W.4K	581 lm	4000K	Blanco/White	21,60 €

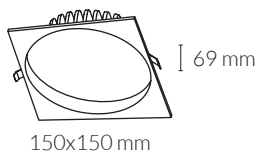

12W 350mA Ø136mm

○	K50316.W.3K	960 lm	3000K	Blanco/White	28,60 €
○	K50316.W.4K	996 lm	4000K	Blanco/White	28,60 €

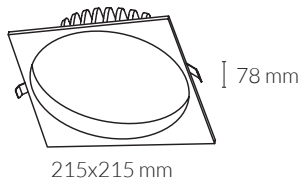

25W 700mA Ø201mm

○	K50317.W.3K	2000 lm	3000K	Blanco/White	52,75 €
○	K50317.W.4K	2075 lm	4000K	Blanco/White	52,75 €

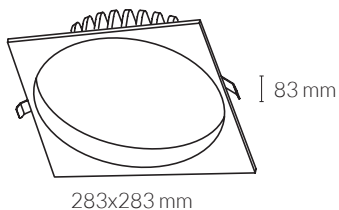

35W 700mA Ø266mm

○	K50318.W.3K	2800 lm	3000K	Blanco/White	88,00 €
○	K50318.W.4K	2905 lm	4000K	Blanco/White	88,00 €

TINA ROUND

REF. K50405/6/7

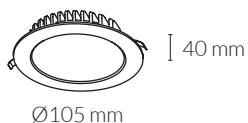

8W 300mA  Ø95mm

	K50405.W.3K	358 lm	3000K	Blanco/White	12,00 €
	K50405.W.4K	459 lm	4000K	Blanco/White	12,00 €
	K50405.G.3K	358 lm	3000K	Oro/Gold	28,00 €
	K50405.G.4K	459 lm	4000K	Oro/Gold	28,00 €
	K50405.GY.3K	358 lm	3000K	Gris/Grey	28,00 €
	K50405.GY.4K	459 lm	4000K	Gris/Grey	28,00 €

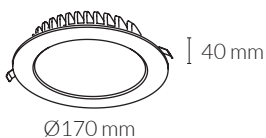

18W 300mA  Ø160mm

	K50406.W.3K	920 lm	3000K	Blanco/White	24,00 €
	K50406.W.4K	1200 lm	4000K	Blanco/White	24,00 €
	K50406.G.3K	920 lm	3000K	Oro/Gold	42,00 €
	K50406.G.4K	1200 lm	4000K	Oro/Gold	42,00 €
	K50406.GY.3K	920 lm	3000K	Gris/Grey	42,00 €
	K50406.GY.4K	1200 lm	4000K	Gris/Grey	42,00 €

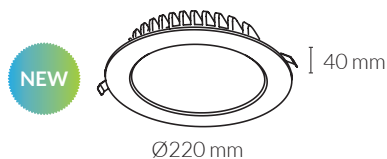

24W 300mA  Ø200mm

	K50407.W.3K	1080 lm	3000K	Blanco/White	29,00 €
	K50407.W.4K	1200 lm	4000K	Blanco/White	29,00 €
	K50407.G.3K	1080 lm	3000K	Oro/Gold	49,00 €
	K50407.G.4K	1200 lm	4000K	Oro/Gold	49,00 €
	K50407.GY.3K	1080 lm	3000K	Gris/Grey	49,00 €
	K50407.GY.4K	1200 lm	4000K	Gris/Grey	49,00 €

TINA SQUARE

REF. K50415/6

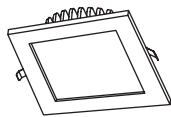

40 mm

109x109 mm

8W 300mA  98x98mm

	K50415.W.3K	358 lm	3000K	Blanco/White	12,00 €
	K50415.W.4K	459 lm	4000K	Blanco/White	12,00 €
	K50415.G.3K	358 lm	3000K	Oro/Gold	28,00 €
	K50415.G.4K	459 lm	4000K	Oro/Gold	28,00 €
	K50415.GY.3K	358 lm	3000K	Gris/Grey	28,00 €
	K50415.GY.4K	459 lm	4000K	Gris/Grey	28,00 €

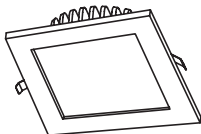

40 mm

180x180 mm

18W 300mA  170x170mm

	K50416.W.3K	920 lm	3000K	Blanco/White	24,00 €
	K50416.W.4K	1200 lm	4000K	Blanco/White	24,00 €
	K50416.G.3K	920 lm	3000K	Oro/Gold	42,00 €
	K50416.G.4K	1200 lm	4000K	Oro/Gold	42,00 €
	K50416.GY.3K	920 lm	3000K	Gris/Grey	42,00 €
	K50416.GY.4K	1200 lm	4000K	Gris/Grey	42,00 €

Oro / Gold
SG 25
.G

Gris / Grey
RAL 9006
.GY

TINY ROUND

REF. K50600

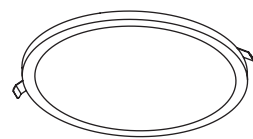

Ø88x22 mm

8W 240mA  Ø75 mm

○ K50600.W.4K 720 lm 4000K Blanco/White 14,00 €

TINY SQUARE

REF. K50601

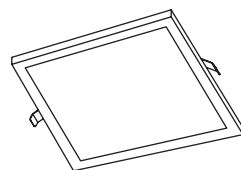

88x88x22 mm

8W 240mA  Ø75 mm

○ K50601.W.4K 720 lm 4000K Blanco/White 14,00 €



CIRQUE

REF. K50400/1

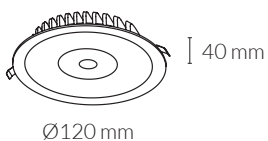
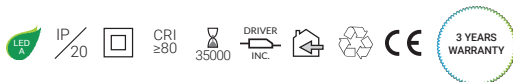

8+5W 300mA Ø110mm

○	K50400.W.3K	788 lm	3000K	Blanco/White	20,50 €
○	K50400.W.4K	803 lm	4000K	Blanco/White	20,50 €

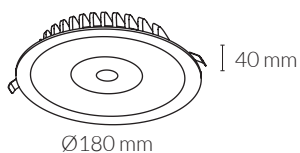

15+7W 300mA Ø170mm

○	K50401.W.3K	1651 lm	3000K	Blanco/White	33,60 €
○	K50401.W.4K	1903 lm	4000K	Blanco/White	33,60 €

CORNER

REF. K50410/1

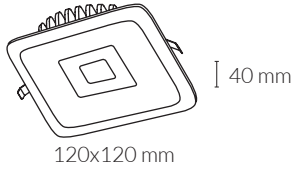
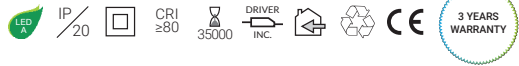

8+5W 300mA  110x110mm

○	K50410.W.3K	813 lm	3000K	Blanco/White	20,50 €
○	K50410.W.4K	838 lm	4000K	Blanco/White	20,50 €

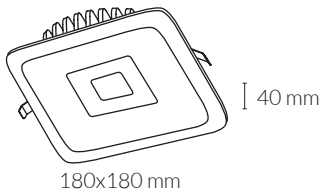

15+7W 300mA  170x170mm

○	K50411.W.3K	1771 lm	3000K	Blanco/White	33,60 €
○	K50411.W.4K	1752 lm	4000K	Blanco/White	33,60 €

PREMIUM

REF. K20123



NEW

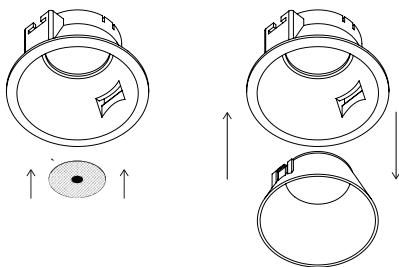
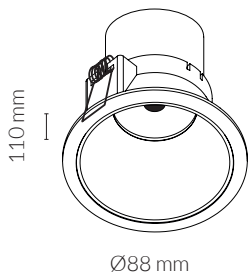
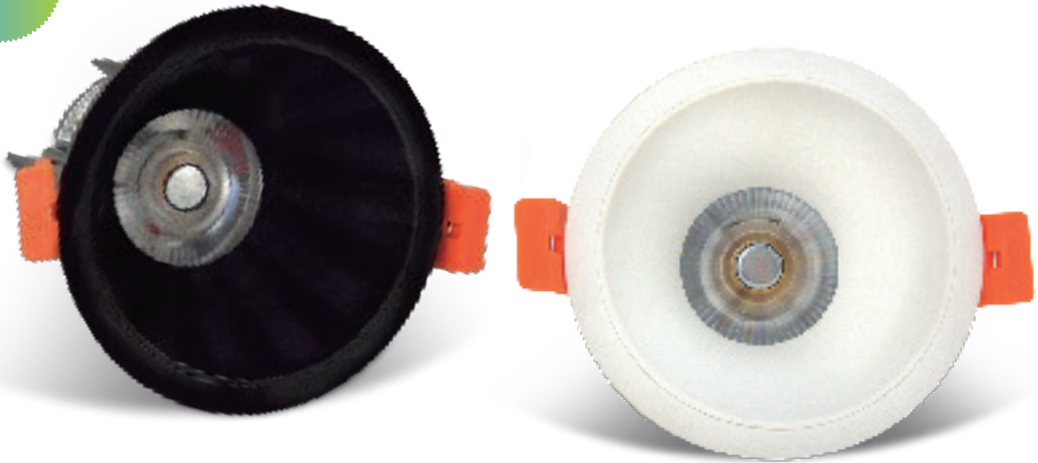

8W 200mA ϕ Ø83mm

○	K20123.W.FC.27K	697 lm	2700K	Blanco/White	32,00 €
○	K20123.W.PL.27K	697 lm	2700K	Blanco/White	32,00 €
●	K20123.BK.FC.27K	697 lm	2700K	Negro/Black	32,00 €
●	K20123.BK.PL.27K	697 lm	2700K	Negro/Black	32,00 €
○	K20123.W.FC.3K	736 lm	3000K	Blanco/White	32,00 €
○	K20123.W.PL.3K	736 lm	3000K	Blanco/White	32,00 €
●	K20123.BK.FC.3K	736 lm	3000K	Negro/Black	32,00 €
●	K20123.BK.PL.3K	736 lm	3000K	Negro/Black	32,00 €
○	K20123.W.FC.4K	774 lm	4000K	Blanco/White	32,00 €
○	K20123.W.PL.4K	774 lm	4000K	Blanco/White	32,00 €
●	K20123.BK.FC.4K	774 lm	4000K	Negro/Black	32,00 €
●	K20123.BK.PL.4K	774 lm	4000K	Negro/Black	32,00 €

PREMIUM

REF. K20123

LENTES

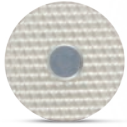

MICRO PRISMÁTICO
Mayor ángulo
40°



HONEY COMB
Intermedio
25°



LUXO

REF. K50150/1/2



8W 200mA Ø76mm

○	K50150.W.3K	800 lm	3000K	Blanco/White	33,00 €
○	K50150.W.4K	820 lm	4000K	Blanco/White	33,00 €
●	K50150.BK.3K	800 lm	3000K	Negro/Black	33,00 €
●	K50150.BK.4K	820 lm	4000K	Negro/Black	33,00 €

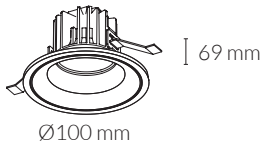

12W 300mA Ø90mm

○	K50151.W.3K	1050 lm	3000K	Blanco/White	38,30 €
○	K50151.W.4K	1100 lm	4000K	Blanco/White	38,30 €
●	K50151.BK.3K	1050 lm	3000K	Negro/Black	38,30 €
●	K50151.BK.4K	1100 lm	4000K	Negro/Black	38,30 €

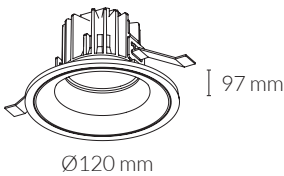

22W 500mA Ø113mm



○	K50152.W.3K	1800 lm	3000K	Blanco/White	56,80 €
○	K50152.W.4K	1900 lm	4000K	Blanco/White	56,80 €
●	K50152.BK.3K	1800 lm	3000K	Negro/Black	56,80 €
●	K50152.BK.4K	1900 lm	4000K	Negro/Black	56,80 €



LUXO ACCESSORIES

REF. KAC50150/2

REFLECTOR

REFLECTOR	REF.	PVP
	KAC50150.D15 - KAC50150.D25 - KAC50150.D60 *	1,48 €
	KAC50152.D16 - KAC50152.D24	3,60 €

* Válido también para K50151 / Also valid for K50151



REBECCA

REF. K53270

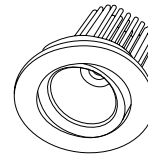

90 mm

Ø93 mm

	3000K	10W	320mA	δ Ø80mm			
○	K53270.W.D40.3K	40°	990 lm	No DIM	Blanco/White	29,00 €	
○	K53270.W.D40.3K.PC	40°	990 lm	Phase Cut	Blanco/White	39,00 €	
○	K53270.W.D60.3K	60°	990 lm	No DIM	Blanco/White	29,00 €	
○	K53270.W.D60.3K.PC	60°	990 lm	Phase Cut	Blanco/White	39,00 €	
●	K53270.SA.D40.3K	40°	990 lm	No DIM	Aluminio rallado/Striped aluminum	29,00 €	
●	K53270.SA.D40.3K.PC	40°	990 lm	Phase Cut	Aluminio rallado/Striped aluminum	39,00 €	
●	K53270.SA.D60.3K	60°	990 lm	No DIM	Aluminio rallado/Striped aluminum	29,00 €	
●	K53270.SA.D60.3K.PC	60°	990 lm	Phase Cut	Aluminio rallado/Striped aluminum	39,00 €	

	4000K	10W	320mA	δ Ø80mm			
○	K53270.W.D40.4K	40°	1010 lm	No DIM	Blanco/White	29,00 €	
○	K53270.W.D40.4K.PC	40°	1010 lm	Phase Cut	Blanco/White	39,00 €	
○	K53270.W.D60.4K	60°	1010 lm	No DIM	Blanco/White	29,00 €	
○	K53270.W.D60.4K.PC	60°	1010 lm	Phase Cut	Blanco/White	39,00 €	
●	K53270.SA.D40.4K	40°	1010 lm	No DIM	Aluminio rallado/Striped aluminum	29,00 €	
●	K53270.SA.D40.4K.PC	40°	1010 lm	Phase Cut	Aluminio rallado/Striped aluminum	39,00 €	
●	K53270.SA.D60.4K	60°	1010 lm	No DIM	Aluminio rallado/Striped aluminum	29,00 €	
●	K53270.SA.D60.4K.PC	60°	1010 lm	Phase Cut	Aluminio rallado/Striped aluminum	39,00 €	

REBECCA SQUARE

REF. K53271



3000K 10W 320mA δ Ø80mm

○	K53271.W.D40.3K	40°	990 lm	No DIM	Blanco/White	29,00 €
○	K53271.W.D40.3K.PC	40°	990 lm	Phase Cut	Blanco/White	39,00 €
○	K53271.W.D60.3K	60°	990 lm	No DIM	Blanco/White	29,00 €
○	K53271.W.D60.3K.PC	60°	990 lm	Phase Cut	Blanco/White	39,00 €
●	K53271.SA.D40.3K	40°	990 lm	No DIM	Aluminio rallado/Striped aluminum	29,00 €
●	K53271.SA.D40.3K.PC	40°	990 lm	Phase Cut	Aluminio rallado/Striped aluminum	39,00 €
●	K53271.SA.D60.3K	60°	990 lm	No DIM	Aluminio rallado/Striped aluminum	29,00 €
●	K53271.SA.D60.3K.PC	60°	990 lm	Phase Cut	Aluminio rallado/Striped aluminum	39,00 €

4000K 10W 320mA δ Ø80mm

○	K53271.W.D40.4K	40°	1010 lm	No DIM	Blanco/White	29,00 €
○	K53271.W.D40.4K.PC	40°	1010 lm	Phase Cut	Blanco/White	39,00 €
○	K53271.W.D60.4K	60°	1010 lm	No DIM	Blanco/White	29,00 €
○	K53271.W.D60.4K.PC	60°	1010 lm	Phase Cut	Blanco/White	39,00 €
●	K53271.SA.D40.4K	40°	1010 lm	No DIM	Aluminio rallado/Striped aluminum	29,00 €
●	K53271.SA.D40.4K.PC	40°	1010 lm	Phase Cut	Aluminio rallado/Striped aluminum	39,00 €
●	K53271.SA.D60.4K	60°	1010 lm	No DIM	Aluminio rallado/Striped aluminum	29,00 €
●	K53271.SA.D60.4K.PC	60°	1010 lm	Phase Cut	Aluminio rallado/Striped aluminum	39,00 €

DARA

REF. K50300/1/2/3



UGR
16.2



81 mm

Ø100 mm

7W 350mA Ø86mm

○	K50300.W.3K	790 lm	3000K	Blanco/White	24,70 €
○	K50300.W.4K	800 lm	4000K	Blanco/White	24,70 €

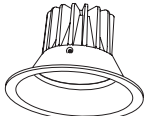

110 mm

Ø160 mm

20W 540mA Ø145mm

○	K50301.W.3K	1840 lm	3000K	Blanco/White	52,40 €
○	K50301.W.4K	2010 lm	4000K	Blanco/White	52,40 €

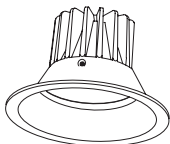

123 mm

Ø190 mm

30W 750mA Ø175mm

○	K50302.W.3K	2764 lm	3000K	Blanco/White	70,40 €
○	K50302.W.4K	2836 lm	4000K	Blanco/White	70,40 €

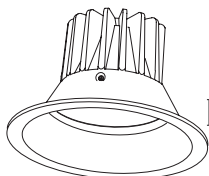

130 mm

Ø230 mm

40W 700mA Ø215mm

○	K50303.W.3K	3200 lm	3000K	Blanco/White	99,00 €
○	K50303.W.4K	3320 lm	4000K	Blanco/White	99,00 €

DARA ACCESSORIES

REF. KAC50300/1/2/3

REFLECTOR



REFLECTOR	REF.	PVP
	KAC50300.D15 - KAC50300.D23 - KAC50300.D60	2,20 €
	KAC50301.D15 - KAC50301.D23 - KAC50301.D60	4,51 €
	KAC50302.D23 - KAC50302.D60	5,17 €
	KAC50303.D60	7,92 €



LASSO

REF. K50700/1

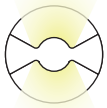
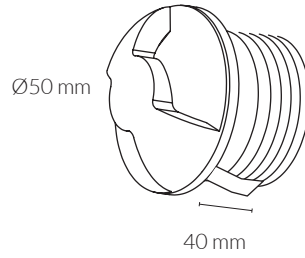

Ø50 mm

	3W	300mA	Ø35mm			
○ K50700.W	275 lm	3000K	Blanco/White	11,00 €		



Ø50 mm

	3W	300mA	Ø35mm			
○ K50701.W	275 lm	3000K	Blanco/White	11,00 €		



K50700.W



K50701.W



TUBO PVC - PVC TUBE

Accesorio de fijación
Fitting accessory

KAC50700 Ø40mm 2,00 €

DETEK

REF. K53265/6/7



IP 44



CRI ≥80

35000

DRIVER INC



CE

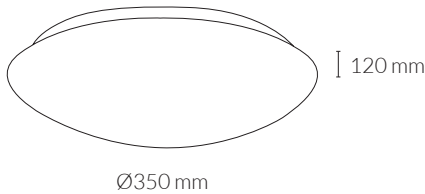

16W 60mA

○	K53265.3K	1040 lm	3000K	Detector de presencia Presence detector	60,00 €
○	K53265.4K	1140 lm	4000K	Detector de presencia Presence detector	60,00 €
○	K53266.3K	1040 lm	3000K	-	53,00 €
○	K53266.4K	1140 lm	4000K	-	53,00 €

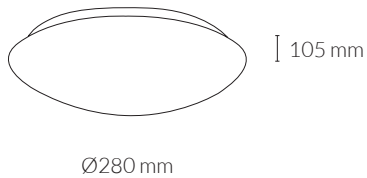

12W 60mA

○	K53267.3K	750 lm	3000K	Detector de presencia Presence detector	50,20 €
○	K53267.4K	800 lm	4000K	Detector de presencia Presence detector	50,20 €

SENSOR MICROONDAS MICROWAVES SENSOR

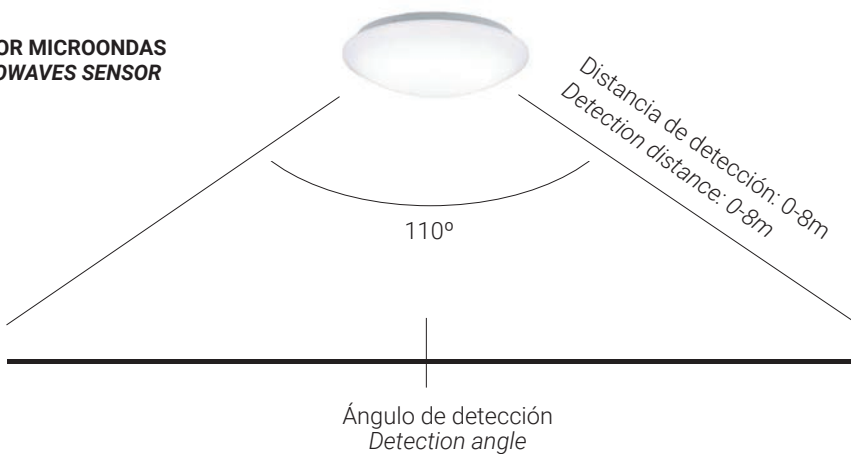

SASHA

REF. K50710/1/2



NEW

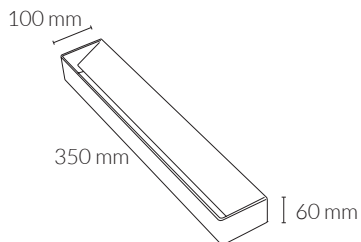
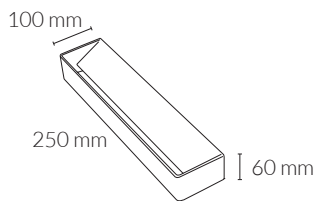
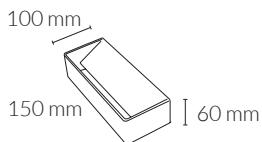

6W 300mA

K50710.W.3K 630 lm 3000K Blanco/White 40,70 €

10W 300mA

K50711.W.3K 1040 lm 3000K Blanco/White 51,65 €

15W 300mA

K50712.W.3K 1530 lm 3000K Blanco/White 64,50 €

SERENA

REF. K50715/6/7



NEW

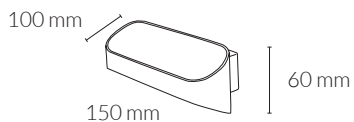

6W 300mA

K50715.W.3K 630 lm 3000K Blanco/White 38,10 €

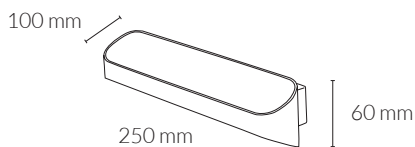

10W 300mA

K50716.W.3K 1040 lm 3000K Blanco/White 45,60 €

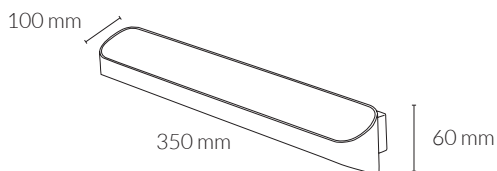

15W 300mA

K50717.W.3K 1530 lm 3000K Blanco/White 55,44 €

PANEL LED

INTEGRATED

LED

GU 10

OUTDOOR

LED STRIPS

TECHNICAL

INFORMATION

SUN

REF. K50140

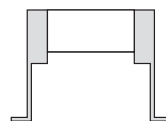
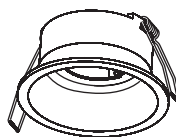

Ø 75x45 mm



db Ø 65 mm

- | | | | |
|---|--------------|--------------|--------|
| ○ | K50140.W.GU | Blanco/White | 6,40 € |
| ● | K50140.BK.GU | Negro/Black | 6,40 € |

DAWN

REF. K50141

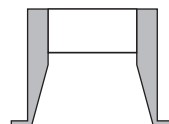
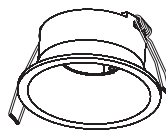

Ø 75x45 mm



db Ø 65 mm

- | | | | |
|---|--------------|--------------|--------|
| ○ | K50141.W.GU | Blanco/White | 6,40 € |
| ● | K50141.BK.GU | Negro/Black | 6,40 € |

MOON

REF. K50110

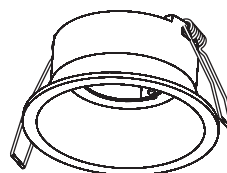

Ø 85x45 mm

 Ø 75 mm

- | | | | |
|---|--------------|--------------|--------|
| ○ | K50110.W.GU | Blanco/White | 9,20 € |
| ● | K50110.BK.GU | Negro/Black | 9,20 € |

VENUS

REF. K50111

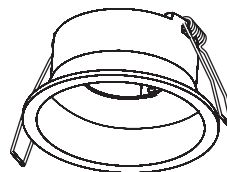

Ø 92x40 mm

 Ø 80 mm

- | | | | |
|---|--------------|--------------|---------|
| ○ | K50111.W.GU | Blanco/White | 10,50 € |
| ● | K50111.BK.GU | Negro/Black | 10,50 € |

OZONE

REF. K50112

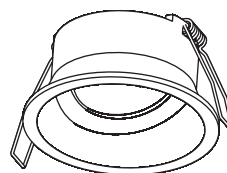

Ø 90x57 mm

Ø 82 mm

○	K50112.W.GU	Blanco/White	12,00 €
●	K50112.BK.GU	Negro/Black	12,00 €

DIP IP 65

REF. K50113

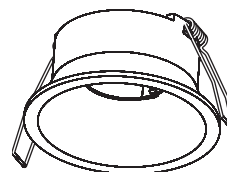

Ø 86x44 mm

Ø 73 mm

○	K50113.W.GU	Blanco/White	9,80 €
●	K50113.BK.GU	Negro/Black	9,80 €

DOT

REF. K50130

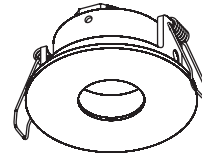

Ø 80x33 mm

Ø 70mm

- | | | | |
|---|--------------|--------------|---------|
| ○ | K50130.W.GU | Blanco/White | 10,80 € |
| ● | K50130.BK.GU | Negro/Black | 10,80 € |

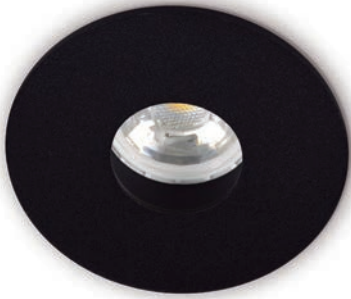

DASH

REF. K50131

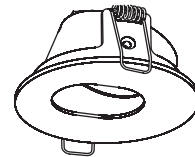

Ø 80x33 mm

Ø 70mm

- | | | | |
|---|--------------|--------------|---------|
| ○ | K50131.W.GU | Blanco/White | 10,80 € |
| ● | K50131.BK.GU | Negro/Black | 10,80 € |

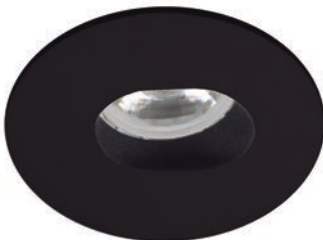

DAISY

REF. K50132

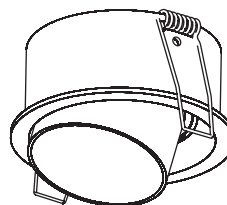

Ø 83x37 mm

Ø 75 mm

- | | | | |
|---|--------------|--------------|---------|
| ○ | K50132.W.GU | Blanco/White | 14,00 € |
| ● | K50132.BK.GU | Negro/Black | 14,00 € |

FOCUS

REF. K50100

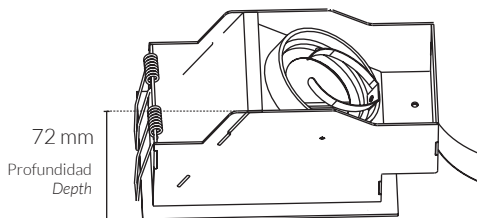

72 mm
Profundidad
Depth

130x85 mm

123x78 mm

- | | | | |
|---|--------------|--------------|---------|
| ○ | K50100.W.GU | Blanco/White | 22,40 € |
| ● | K50100.BK.GU | Negro/Black | 22,40 € |



SAT ROUND

REF. K50126

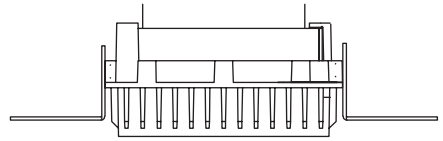

Ø 81x62 mm

db Ø 96 mm



- | | | | |
|---|--------------|--------------|---------|
| ○ | K50126.W.GU | Blanco/White | 26,40 € |
| ● | K50126.BK.GU | Negro/Black | 26,40 € |

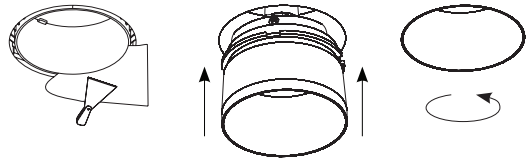

SAT SQUARE

REF. K50125

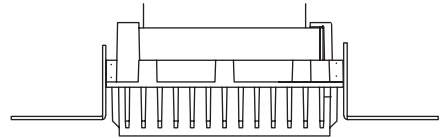

73x73x52 mm

db 85x85 mm



- | | | | |
|---|--------------|--------------|---------|
| ○ | K50125.W.GU | Blanco/White | 24,40 € |
| ● | K50125.BK.GU | Negro/Black | 24,40 € |

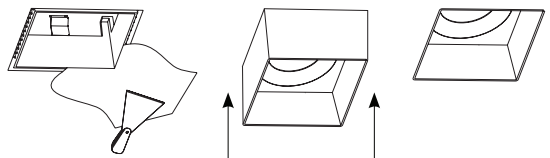

ACCESORIOS GU10

GU10 ACCESSORIES

KLB



Ø50x50 mm

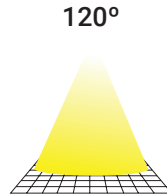
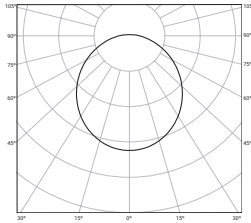

7W - 120°

○	KLB3K.W	GU10	570 lm	3000K	Blanco/White	4,80 €
○	KLB4K.W	GU10	623 lm	4000K	Blanco/White	4,80 €
●	KLB3K.BK	GU10	570 lm	3000K	Negro/Black	4,80 €
●	KLB4K.BK	GU10	623 lm	4000K	Negro/Black	4,80 €

PANEL LED

INTEGRATED

LED

GU10

OUTDOOR

LED STRIPS

TECHNICAL

INFORMATION

BOLETUS

REF. K52400/1

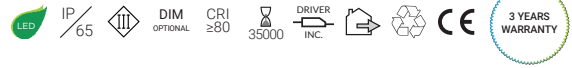

K52400

K52401

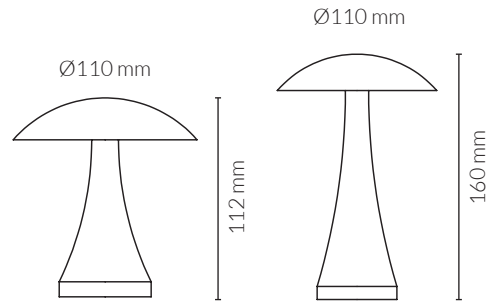

6,3W 500mA

● K52400.BK	85 lm	3000K	56,00 €
● K52401.BK	85 lm	3000K	60,00 €



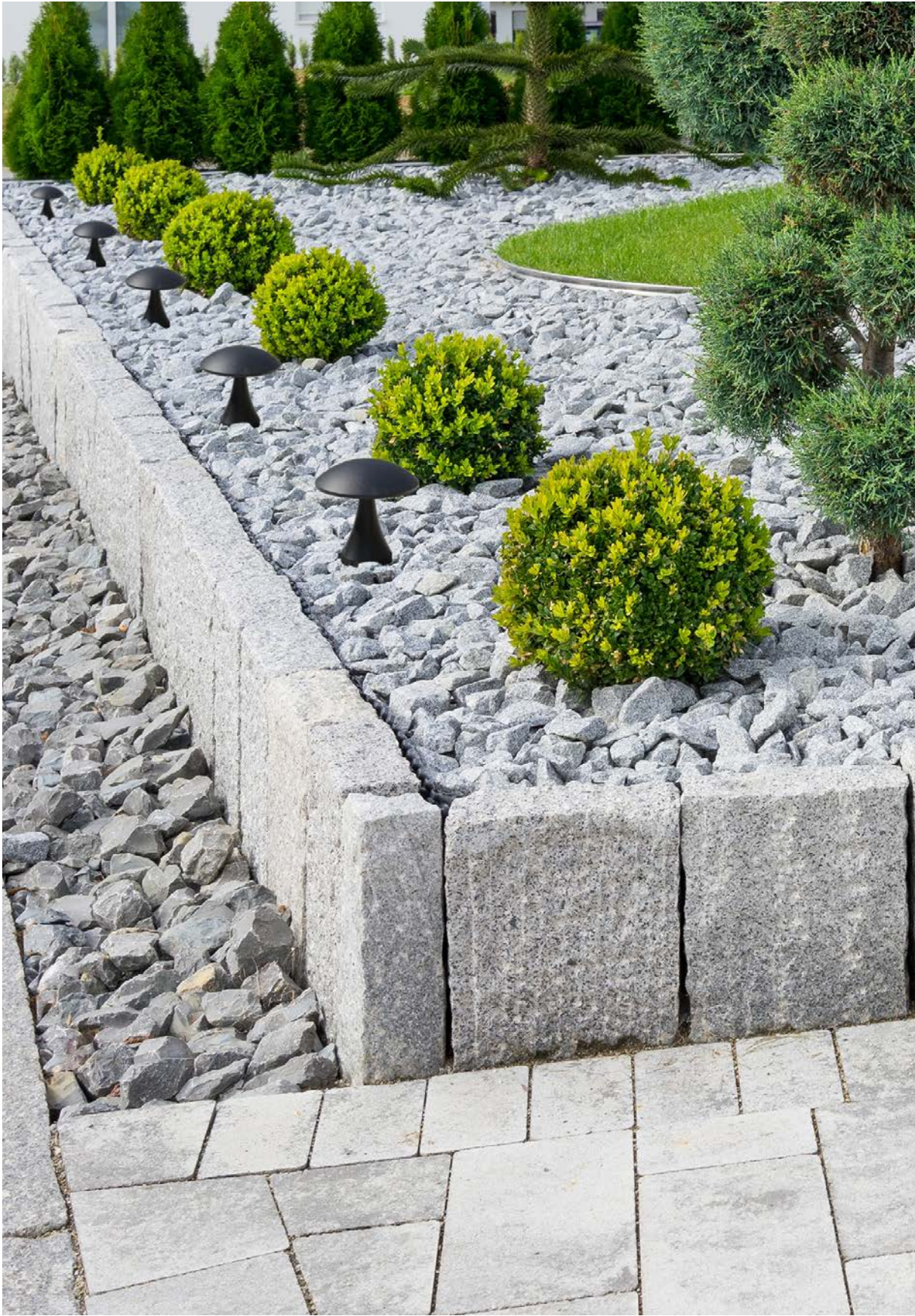

TOWER

REF. K52500/1/2

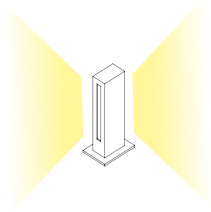
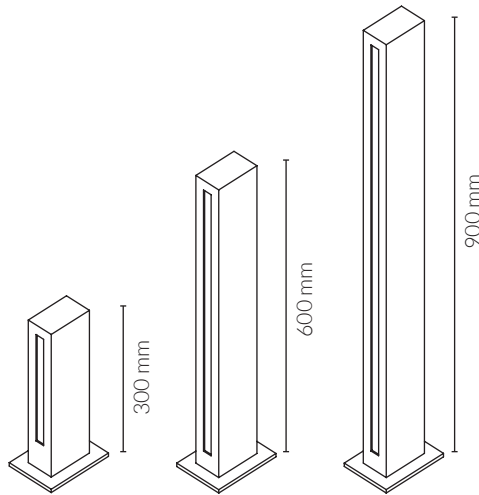

● K52500.GY	16,7 W	24 V	356 lm	3000K	142,50 €
● K52501.GY	39 W	24 V	806 lm	3000K	211,40 €
● K52502.GY	57 W	24 V	1068 lm	3000K	276,40 €





MAILBOX

REF. K52100

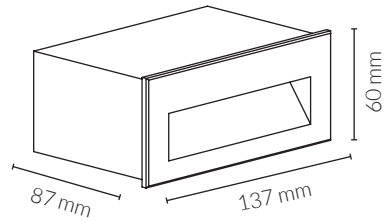

132x55 mm

	K52100.GY	3,8 W	107 lm	3000K	Gris/Grey	51,20 €
	K52100.BK	3,8 W	107 lm	3000K	Negro/Black	51,20 €

HUNTER

REF. K52200

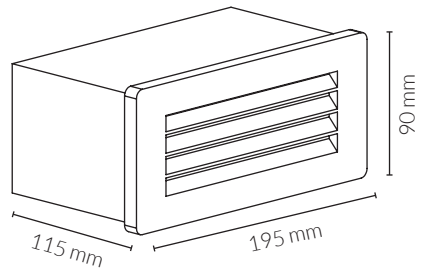

190x85 mm

	K52200.BK	7,6 W	114 lm	3000K	Negro/Black	77,60 €
--	-----------	-------	--------	-------	-------------	---------

HAMMER ROUND

REF. K52300

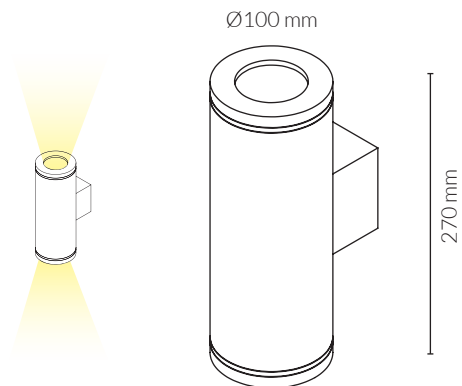

●	K52300.GY	15,3+15,3 W	1190 lm	3000K	Gris/Grey	158,80 €
●	K52300.BK	15,3+15,3 W	1190 lm	3000K	Negro/Black	158,80 €

HAMMER SQUARE

REF. K52301

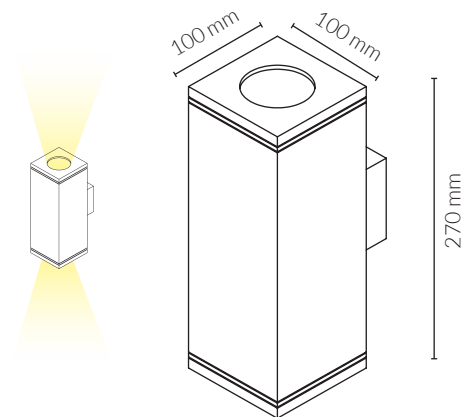

●	K52301.GY	15,3+15,3 W	1190 lm	3000K	Gris/Grey	164,80 €
●	K52301.BK	15,3+15,3 W	1190 lm	3000K	Negro/Black	164,80 €

STORM

REF. K52600/1/2/3/4/5



2 YEARS WARRANTY

10W 300mA

●	K52600.BK.3K	3000K	900 lm	Negro/Black	115x115x40 mm	16,00 €
●	K52600.BK.6K	6000K	1000 lm	Negro/Black	115x115x40 mm	16,00 €
○	K52600.W.3K	3000K	900 lm	Blanco/White	115x115x40 mm	16,00 €
○	K52600.W.6K	6000K	1000 lm	Blanco/White	115x115x40 mm	16,00 €

20W 600mA

●	K52601.BK.3K	3000K	1800 lm	Negro/Black	180x175x46 mm	24,80 €
●	K52601.BK.6K	6000K	2000 lm	Negro/Black	180x175x46 mm	24,80 €
○	K52601.W.3K	3000K	1800 lm	Blanco/White	180x175x46 mm	24,80 €
○	K52601.W.6K	6000K	2000 lm	Blanco/White	180x175x46 mm	24,80 €

30W 900mA

●	K52602.BK.3K	3000K	2700 lm	Negro/Black	226x220x55 mm	35,60 €
●	K52602.BK.6K	6000K	3000 lm	Negro/Black	226x220x55 mm	35,60 €
○	K52602.W.3K	3000K	2700 lm	Blanco/White	226x220x55 mm	35,60 €
○	K52602.W.6K	6000K	3000 lm	Blanco/White	226x220x55 mm	35,60 €

50W 1500mA

●	K52603.BK.3K	3000K	4500 lm	Negro/Black	282x270x66 mm	44,40 €
●	K52603.BK.6K	6000K	5000 lm	Negro/Black	282x270x66 mm	44,40 €
○	K52603.W.3K	3000K	4500 lm	Blanco/White	282x270x66 mm	44,40 €
○	K52603.W.6K	6000K	5000 lm	Blanco/White	282x270x66 mm	44,40 €

100W 2x1500mA

●	K52604.BK.3K	3000K	9000 lm	Negro/Black	282x320x80 mm	90,00 €
●	K52604.BK.6K	6000K	10000 lm	Negro/Black	282x320x80 mm	90,00 €
○	K52604.W.3K	3000K	9000 lm	Blanco/White	282x320x80 mm	90,00 €
○	K52604.W.6K	6000K	10000 lm	Blanco/White	282x320x80 mm	90,00 €

150W 3x1500mA

●	K52605.BK.3K	3000K	13500 lm	Negro/Black	337x365x88 mm	127,60 €
●	K52605.BK.6K	6000K	15000 lm	Negro/Black	337x365x88 mm	127,60 €
○	K52605.W.3K	3000K	13500 lm	Blanco/White	337x365x88 mm	127,60 €
○	K52605.W.6K	6000K	15000 lm	Blanco/White	337x365x88 mm	127,60 €

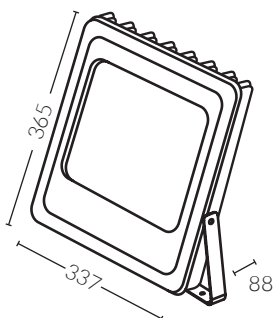
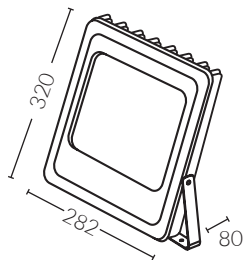
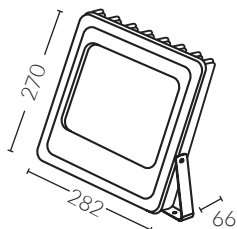
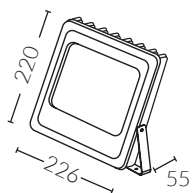
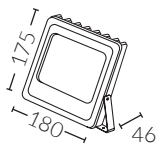
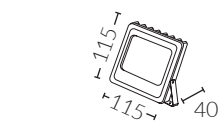

* Medidas en mm / Measures in mm



PANEL LED

INTEGRATED

LED

GU10

OUTDOOR

LED STRIPS

TECHNICAL

INFORMATION

TIRAS DE LED

LED STRIPS

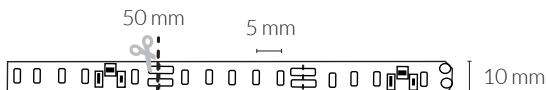

120 LEDs/m	LUMIFLEX CC 28											5m - CRI≥80	
	REF	Tensión Voltage	T°. Color	LEDs/m	W/m	lm/m	IP	LED type	EE	Ancho / Wide (mm)	mm	PVP	
	K55001.CC.27K.20	24V	2700K	120	28,8	2448	IP 20	2835	A+	10	50	167,60 €	
	K55001.CC.3K.20	24V	3000K	120	28,8	2592	IP 20	2835	A+	10	50	167,60 €	
	K55001.CC.4K.20	24V	4000K	120	28,8	2736	IP 20	2835	A+	10	50	167,60 €	
	K55001.CC.55K.20	24V	5500K	120	28,8	2880	IP 20	2835	A+	10	50	167,60 €	

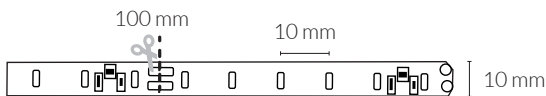

60 LEDs/m	FLEX PRO CC 20											5m - CRI≥90	
	REF	Tensión Voltage	T°. Color	LEDs/m	W/m	lm/m	IP	LED type	EE	Ancho / Wide (mm)	mm	PVP	
	K55002.CC.27K.20	24V	2700K	60	20	1400	IP 20	5630	A	10	100	126,00 €	
	K55002.CC.3K.20	24V	3000K	60	20	1500	IP 20	5630	A	10	100	126,00 €	
	K55002.CC.4K.20	24V	4000K	60	20	1560	IP 20	5630	A	10	100	126,00 €	
	K55002.CC.55K.20	24V	5500K	60	20	1600	IP 20	5630	A	10	100	126,00 €	

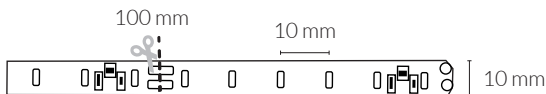

60 LEDs/m	FLEX CV ECO											5m - CRI≥80	
	REF	Tensión Voltage	T°. Color	LEDs/m	W/m	lm/m	IP	LED type	EE	Ancho / Wide (mm)	mm	PVP	
	K55003.CV.27K.20	24V	2700K	60	7,2	561,6	IP 20	3014	A+	10	100	44,00 €	
	K55003.CV.3K.20	24V	3000K	60	7,2	612	IP 20	3014	A+	10	100	44,00 €	
	K55003.CV.4K.20	24V	4000K	60	7,2	648	IP 20	3014	A+	10	100	44,00 €	
	K55003.CV.55K.20	24V	5500K	60	7,2	690	IP 20	3014	A+	10	100	44,00 €	

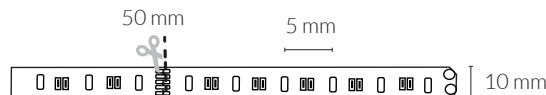

120 LEDs/m	FLEX CV 15											5m - CRI≥80	
	REF	Tensión Voltage	T°. Color	LEDs/m	W/m	lm/m	IP	LED type	EE	Ancho / Wide (mm)	mm	PVP	
	* K55008.CV.27K.20	24V	2700K	120	15	1100	IP 20	3014	A+	10	50	79,80 €	
	* K55008.CV.27K.65	24V	2700K	120	15	1100	IP 65	3014	A+	10	50	89,90 €	
	* K55008.CV.3K.20	24V	3000K	120	15	1200	IP 20	3014	A+	10	50	79,80 €	
	* K55008.CV.3K.65	24V	3000K	120	15	1200	IP 65	3014	A+	10	50	89,90 €	
	* K55008.CV.4K.20	24V	4000K	120	15	1400	IP 20	3014	A+	10	50	79,80 €	
	* K55008.CV.4K.65	24V	4000K	120	15	1400	IP 65	3014	A+	10	50	89,90 €	
	* K55008.CV.55K.20	24V	5500K	120	15	1500	IP 20	3014	A+	10	50	79,80 €	
	* K55008.CV.55K.65	24V	5500K	120	15	1500	IP 65	3014	A+	10	50	89,90 €	

2700K - 6500K

CAMBIO DE T° DE COLOR
DYNAMIC WHITE

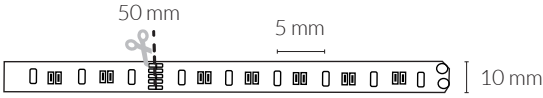

120 LEDs/m	FLEX CC BLANCO DINÁMICO											5m - CRI≥80	
	REF	Tensión Voltage	T°. Color	LEDs/m	W/m	lm/m	IP	LED type	EE	Ancho / Wide (mm)	mm	PVP	
	K55004.CC.TW.20	24V	2700K-6500K	120	19,2	561,6	IP 20	3527	A+	10	50	148,00 €	

RGBW

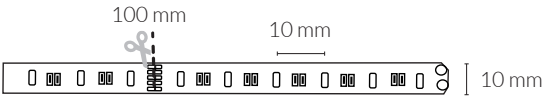

60 LEDs/m	SHOWFLEX CV RGBW											5m - CRI≥80	
	REF	Tensión Voltage	T°. Color	LEDs/m	W/m	lm/m	IP	LED type	EE	Ancho / Wide (mm)	mm	PVP	
	K55007.CV.RGBW.20	24V	3000K RGB	60	18	600	IP 20	5050	A	10	100	106,00 €	

RGB



60 LEDs/m	SHOWFLEX CV RGB ECO											5m - CRI≥65	
	REF	Tensión Voltage	T°. Color	LEDs/m	W/m	lm/m	IP	LED type	EE	Ancho / Wide (mm)	mm	PVP	
	K55006.CV.RGB.20	24V	RGB	30	7,2	216	IP 20	5050	A	10	166,60	54,00 €	

* Corte a medida (Máx 50m) - 4,00 €
* Custom cut (Máx 50m) - 4,00 €

PERFILES PARA TIRAS DE LED

LED STRIPS PROFILES

1_ Elige el modelo de perfil / Choose the profile model:

KP50001

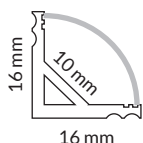

Para tiras LED de IP20.
Disponible en gris anodizado.
For IP20 LED strips.
Available in anodized grey.

KP50002

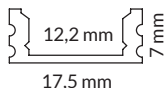

Para tiras LED de IP20.
Disponible en gris anodizado.
For IP20 LED strips.
Available in anodized grey.

KP50003

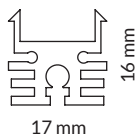

Para tiras LED de IP20.
Disponible en gris anodizado.
For IP20 LED strips.
Available in anodized grey.

KP50004

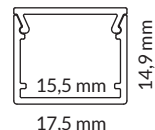

Para tiras LED de IP65.
Disponible en gris anodizado o negro.
For IP65 LED strips.
Available in anodized grey or black.

2_ Monta tu perfil / Set your profile:

- 1 - Combina las medidas de perfil para conseguir una longitud igual o superior a la deseada.
(Si es superior, posteriormente se cortará el perfil sobrante).

*Combine profile measures to achieve a length equal to or higher than the desired measure.
(If it is higher, then the excess profile will be cut).*

- 2 - Repite el paso anterior eligiendo el tipo de difusor.

Repeats the previous step choosing the optic cover.

- 3 - Elige las tapas laterales.

Choose sides caps.

- 4 - Elige el número de clips.

(Se recomienda un clip por metro, con un mínimo de dos, independientemente de la medida, para tener dos puntos de sujeción).

Choose number of clips.

(One fixing clip per meter is recommended, with a minimum of 2, regardless of length, in order to have two attachment points).

- 5 - Por último, añade el corte si fuera necesario.

Finally, if necessary add cut.

3_ Referencias para montar tu perfil / References to set your profile:

1_ Elige el modelo de perfil / Choose the profile model:

Perfil Profile	Longitud del perfil Profile length	Color Color	Precio Price
KP50001.01	2 m	Gris anodizado/Anodized grey	13,60€
KP50002.01	2 m	Gris anodizado/Anodized grey	11,80€
KP50003.01	2 m	Gris anodizado/Anodized grey	17,00€
KP50004.GY.01	2 m	Gris anodizado/Anodized grey	15,00€
KP50004.BK.01	2 m	Negro/Black	16,00€
KP50001.02	3 m	Gris anodizado/Anodized grey	20,40€
KP50002.02	3 m	Gris anodizado/Anodized grey	17,70€
KP50003.02	3 m	Gris anodizado/Anodized grey	25,50€
KP50004.GY.02	3 m	Gris anodizado/Anodized grey	22,00€
KP50004.BK.02	3 m	Negro/Black	24,00€

2_ Elige el difusor / Choose optic cover:

OPAL			TRANSPARENTE / TRANSPARENT		
Difusor Optic cover	Longitud del perfil Profile length	Precio Price	Difusor Optic cover	Longitud del perfil Profile length	Precio Price
KD50001.OP.01	2 m	11,00€	KD50001.OT.01	2 m	9,20€
KD50002.OP.01	2 m	8,80€	KD50002.OT.01	2 m	7,20€
KD50003.OP.01	2 m	11,66€	KD50003.OT.01	2 m	10,00€
KD50004.OP.01	2 m	8,80€	KD50004.OT.01	2 m	7,20€
KD50001.OP.02	3 m	16,50€	KD50001.OT.02	3 m	13,80€
KD50002.OP.02	3 m	13,20€	KD50002.OT.02	3 m	10,80€
KD50003.OP.02	3 m	17,49€	KD50003.OT.02	3 m	15,00€
KD50004.OP.02	3 m	12,54€	KD50004.OT.02	3 m	10,80€

3_ Elige tapas / Choose caps:

SIN AGUJERO / WITHOUT HOLE		CON AGUJERO / WITH HOLE	
Tapas / Caps	Precio / Price	Tapas / Caps	Precio / Price
KPEC50001 / KPEC50002 / KPEC50003	0,40€	KPEC50001.H / KPEC50002.H / KPEC50003.H	0,40€
KPEC50004	1,00€	KPEC50004.H	1,00€

4_ Clips de sujeción / Fixing clips:

Clips de sujeción / Fixing clips	Precio / Price
KC50001 / KC50002 / KC50003	0,20€
KC50004	0,60€

5_ Corte / Cut:

Corte / Cut	Precio / Price
KPCUT	8,00€

Ejemplo de un perfil KP50001 de 6,5m con difusor opal / Example of 6,5m KP50001 profile with opal optic cover:

(1 KP50001.01 + 2 KP50001.02) + (1 KD50001.OP.01 + 2 KD50001.OP.02) + (1 KPEC50001 + 1 KPEC50001.H) + 7 KC50001 + KPCUT

EQUIPOS PARA TIRAS DE LED

LED STRIPS DRIVERS

	KD55100.20	ELT	TIRAS LED LED STRIPS	20W	148x45,8x22,5 mm	IP20	24V	21,05 €
	KD55100.30	ELT	TIRAS LED LED STRIPS	30W	148x45,8x22,5 mm	IP20	24V	56,35 €
	KD55100.50	ELT	TIRAS LED LED STRIPS	50W	175x67x32 mm	IP20	24V	79,25 €
	KD55100.75	ELT	TIRAS LED LED STRIPS	75W	192x45,8x63 mm	IP20	24V	81,30 €
	KD55101.100	TRIDONIC	TIRAS LED LED STRIPS	96W	300x44x23 mm	IP20	24V	123,20 €
	KD55101.180	TRIDONIC	TIRAS LED LED STRIPS	180W	280x64x31 mm	IP20	24V	149,05 €

REGULADORES PARA TIRAS DE LED

LED STRIPS DIMMERS





	<p>REGULADOR TIRA DE LED / DIMMER LED STRIP</p> <p>KDFLEX1 6A/2CH TOUCH LED 4 ZONE 2.4G 144W (12V) 288W (24V) 152x41x28 mm</p>	31,60 €
--	--	---------

ACCESORIOS FLEX BLANCO DINÁMICO

DIMMERS DYNAMIC WHITE FLEX

	<p>CONTROLADOR TEMPERATURA DE COLOR CONTROL COLOR TEMPERATURE</p> <p>KACFLEX1 4 ZONE 2.4G 4A/2CH 96W (12V) 192W (24V) 85x45x23 mm</p>	30,40 €
	<p>CONTROLADOR TEMPERATURA DE COLOR CONTROL COLOR TEMPERATURE</p> <p>KACFLEX2 4 ZONE 2.4G 6A/4CH 144W (12V) 288W (24V) 152x41x28 mm</p>	31,60 €

ACCESORIOS RGB RGB ACCESSORIES

	<p>AMPLIFICADOR RGB / RGB AMPLIFIER</p> <p>KACRGB1 DC12V-24V 3 CH 4A/CH 144W (12V) 288W (24V) 105x64x23 mm</p>	<p>14,00 €</p>
	<p>CONTROLADOR RGB / RGB CONTROL</p> <p>KACRGB2 DC12V-24V 3 CH 4A/CH 144W (12V) 288W (24V) 85x45x23 mm</p>	<p>32,40 €</p>
	<p>CONTROLADOR RGB / RGB CONTROL</p> <p>KACRGB3 DC12V-24V 3 CH 6A/CH 144W (12V) 288W (24V) 83x79x32 mm</p>	<p>34,00 €</p>
	<p>CONTROLADOR RGB PARED / RGB WALL CONTROL</p> <p>KACRGB4 DC12V-24V 3 CH 4A/CH 144W (12V) 288W (24V) 86x86x32 mm</p>	<p>50,80 €</p>
	<p>DECODIFICADOR DMX / DMX LED CONTROL</p> <p>KACRGB5 DC12V-24V 3 CH 4A/CH 144W (12V) 288W (24V) 177x40x32 mm</p>	<p>34,00 €</p>

ACCESORIOS SHOWFLEX RGBW SHOWFLEX RGBW ACCESSORIES

	<p>CONTROLADOR RGBW / RGBW CONTROL</p> <p>KACRGBW1 DC12V-24V 6A/4CH 288W (12V) 576W (24V) 153x41x29 mm</p>	<p>31,60 €</p>
---	--	----------------

PANEL LED

INTEGRATED

LED

GU10

OUTDOOR

LED STRIPS

TECHNICAL

INFORMATION

MEDIDAS DE CORTE CUT OUT

K50700	LASSO	Ø35 mm
K50701	LASSO	Ø35 mm
K50600	TINY ROUND	Ø75 mm
K50601	TINY SQUARE	Ø75 mm
K50150	LUXO	Ø76 mm
K53270	REBECCA	Ø80 mm
K53271	REBECCA SQUARE	Ø80 mm
K50300	DARA	Ø86 mm
K50310	LIM ROUND	Ø86 mm
K50315	LIM SQUARE	Ø86 mm
K50151	LUXO	Ø90 mm
K53252	MARJAL SQUARE	Ø90 mm
K53262	MARJAL	Ø90 mm
K50405	TINA ROUND	Ø95 mm
K50415	TINA SQUARE	98x98 mm
K50210	DISC SQUARE	100x100 mm
K50200	DISC	Ø108 mm
K53100	MIRANDA	Ø109 mm
K53105	MIRANDA SQUARE	109x109 mm
K50400	CIRQUE	Ø110 mm
K50410	CORNER	110x110 mm
K50152	LUXO	Ø113 mm
K50212	DISC SQUARE	120x120 mm
K53251	MARJAL SQUARE	Ø135 mm
K53261	MARJAL	Ø135 mm
K50311	LIM ROUND	Ø136 mm
K50316	LIM SQUARE	Ø136 mm
K50301	DARA	Ø145 mm
K50201	DISC	Ø150 mm
K50211	DISC SQUARE	150x150 mm
K53101	MIRANDA	Ø159 mm
K53106	MIRANDA SQUARE	159x159 mm
K50401	CIRQUE	Ø170 mm
K50406	TINA ROUND	Ø170 mm
K50411	CORNER	170x170 mm
K50416	TINA SQUARE	170x170 mm
K50302	DARA	Ø175 mm
K50407	TINA ROUND	Ø200 mm

K50312	LIM ROUND	Ø201 mm
K50317	LIM SQUARE	Ø201 mm
K50202	DISC	Ø205 mm
K53250	MARJAL SQUARE	Ø210 mm
K53260	MARJAL	Ø210 mm
K53102	MIRANDA	Ø214 mm
K53107	MIRANDA SQUARE	214x214 mm
K50303	DARA	Ø215 mm
K50313	LIM ROUND	Ø266 mm
K50318	LIM SQUARE	Ø266 mm
K50203	DISC	Ø280 mm
K50206	DISC	Ø580 mm

SÍMBOLOS

SIMBOLS



Conforme a las directivas europeas y la norma EN 60598
According to european directives and EN 60598



Depositar los residuos en un centro de recogida autorizado
Leave waste in an authorized recycling center



Corte rectangular
Rectangular cut



Corte circular
Circular cut



Clase I (Clases de protección contra choques eléctricos)
Class I (Protection classes against electric shocks)



Clase II (Clases de protección contra choques eléctricos)
Class II (Protection classes against electric shocks)



Clase III (Clases de protección contra choques eléctricos)
Class III (Protection classes against electric shocks)



Eficiencia energética LED
LED energy efficiency



Garantía
Warranty



Temperatura de color 3000K
3000K Color temperature



Temperatura de color 4000K
4000K Color temperature



Temperatura de color 6000K
6000K Color temperature



Portalámparas GU10
GU10 Lampholder



Nuevo producto. Consultar existencias
New product. Consult stock



Regulador opcional bajo consulta
Optional dimmer on request



Equipo incluido
Driver included



Equipo (o transformador) no incluido
Driver (or transformer) not included



Lámpara no incluida
Lamp not included



Grado de protección contra polvo y humedad
Degree of protection against dust and humidity



Vida útil
Life time



Grados de basculación
Tilting degree



Grados de giro
Rotation degrees



Ángulo de apertura del reflector
Reflector opening angle



Índice de reproducción cromática
Color rendering index



Uso Interior
Indoor use



Uso exterior
Outdoor use



Wattios
Watts



Vatios máximos
Maximum watts



Miliamperios
Milliamps

FOTOMETRÍAS PHOTOMETRICS

WINNER - ELITE - CHESS

REF: K50503 - K50504 - K50505 - K50506 - K50500 - K50501

3000K - 4000K - 6000K

OPAL

3000K

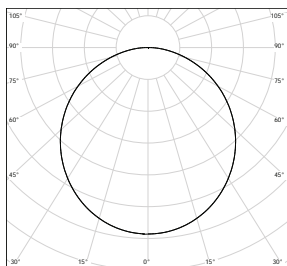

4000K

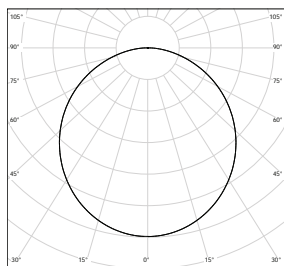

6000K

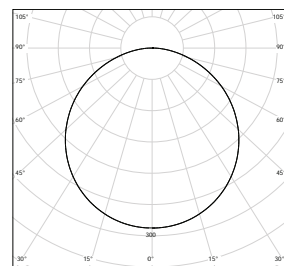

MICROPRISMÁTICO MICROPRISMATIC

3000K

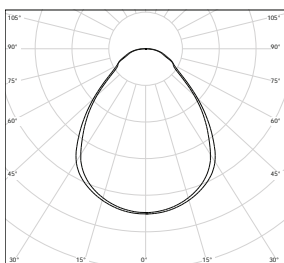

4000K

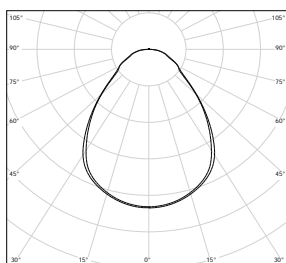

6000K

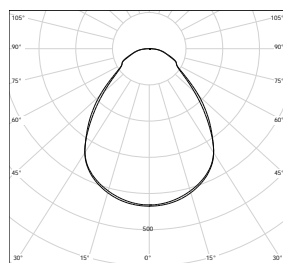

MARJAL - MARJAL SQUARE

REF: K53262 - K553261 - K53260 -
K53252 - K53251 - K53250

3000K - 4000K

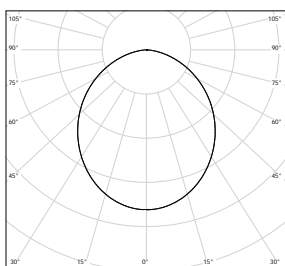

LIM ROUND - LIM SQUARE

REF: K50310 - K50311 - K50312
- K50313 - K50315 - K50316 - K50317-
K50318

3000K - 4000K

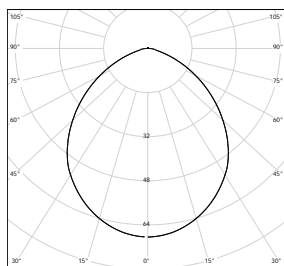

TINA ROUND - TINA SQUARE

REF: K50405 - K50406 - K50415 -
K50416

3000K - 4000K

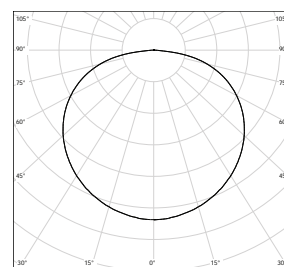

DISC - DISC SURFACE

REF: K50200 - K50201 - K50202 -
K50203 - K50206 - K50220 - K50221
K50222 - K50223 - K50225 - K50226

3000K - 4000K - 6000K

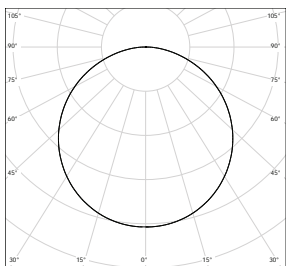

**DISC SQUARE /
DISC SQUARE SURFACE**

REF: K50210 - K50211 - K50212 -
K50230 - K50231 - K50232 - K50233

3000K - 4000K - 6000K

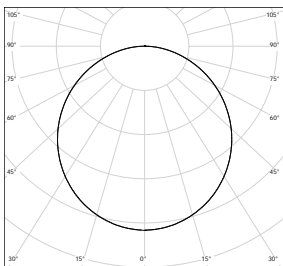

REBECCA - REBECCA SQUARE

REF: K53270 - K53271

3000K - 4000K

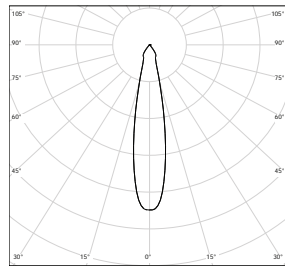

CIRQUE

REF: K50400 - K50401

3000K - 4000K

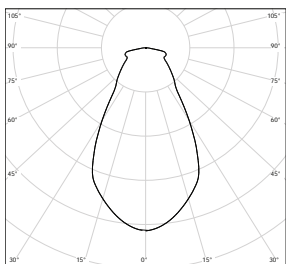

CORNER

REF: K50410 - K50411

3000K - 4000K

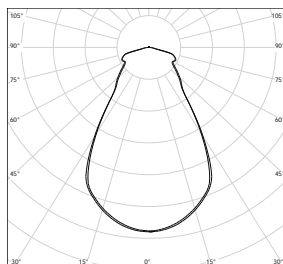

DETEK

REF: K53265 - K53266

3000K - 4000K

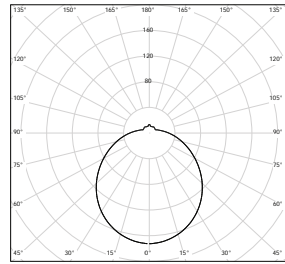

DARA

REF: K50300 - K50301 - K50302 -
K50303

3000K - 4000K

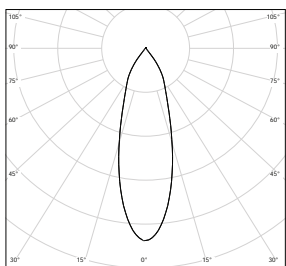

GRADO DE PROTECCIÓN IP

IP DEGREE OF PROTECTION

Según la Norma IEC 60529, el grado de protección IP especifica los diferentes niveles de protección aportados por los contenedores que resguardan los componentes de los equipos eléctricos o electrónicos. Cuanto mayor es el grado de protección IP, más protegido está el equipamiento.

Un grado de protección IP XY indica lo siguiente:

As IEC 60529 standard says, the IP protection degree specifies the different protection levels provided by the containers that protect the components in electrical or electronic equipment. The greater the IP protection degree, the more protected the equipment is. An IP XY protection degree indicates the following:

X: Describe el nivel de protección contra polvo y otras partículas / *Describes the level of protection against dust and other particles*

X	Grado de protección contra polvo / Protection grade against dust
0	Sin protección / <i>Without protection</i>
1	Protegida contra sólidos de más de 50 mm / <i>Protected against solids bigger than 50 mm</i>
2	Protegida contra sólidos de más de 12 mm / <i>Protected against solids bigger than 12 mm</i>
3	Protegida contra sólidos de más de 2,5 mm / <i>Protected against solids bigger than 2,5 mm</i>
4	Protegida contra sólidos de más de 1 mm / <i>Protected against solids bigger than 1 mm</i>
5	Protegida contra la entrada de polvo / <i>Protection against the entrance of dust</i>
6	Totalmente protegida del polvo / <i>Full protected against dust</i>

Y: Describe el nivel de protección contra líquidos / *Describes the level against liquids*

Y	Grado de protección contra líquidos / Protection grade against liquids
0	Sin protección / <i>Without protection</i>
1	Protegida contra la caída vertical de gotas de agua / <i>Protected against drops of water falling vertically</i>
2	Protegida contra la caída de gotas de agua con una inclinación máxima de 15° <i>Protected against drops of water falling at a maximum inclination of 15°</i>
3	Protegida contra agua pulverizada / <i>Protected against sprayed water</i>
4	Protegida contra las proyecciones de agua / <i>Protected against splashes of water</i>
5	Protegida contra los chorros de agua / <i>Protected against jets of water</i>
6	Protegida contra mar gruesa / <i>Protected against heavy tide</i>
7	Protegida contra los efectos de la inmersión / <i>Protected against plunging effects</i>
8	Protegida contra la inmersión prolongada / <i>Protected against long immersion</i>

*Los procedimientos especializados de limpieza no están cubiertos por los grados de protección IP. Se recomienda que los fabricantes suministren, si es necesario, una adecuada información en lo referente a los procedimientos de limpieza. Esto está de acuerdo con las recomendaciones contenidas en la Norma IEC 60529 para los procedimientos de limpieza especiales.

**Specialized cleaning procedures are not covered by IP ratings. It is recommended that manufacturers provide, if necessary, adequate information regarding cleaning procedures. This is in accordance with the recommendations contained in IEC 60529 for special cleaning procedures.*

CLASES DE PROTECCIÓN CONTRA CHOQUES ELÉCTRICOS

PROTECTION CLASSES AGAINST ELECTRIC SHOCKS

According to the type of protection they offer against electric shocks, light fittings are classified as: Class I, Class II and Class III.

Las luminarias se clasifican en función de su tipo de protección contra los choques eléctricos, en: Clase I, Clase II y Clase III.



Class I: Luminarias en la que la protección contra los choques eléctricos no recae exclusivamente sobre el aislamiento principal, sino que comprende una medida de seguridad suplementaria bajo la forma de medios de conexión de las partes conductoras accesibles con un conductor de protección puesto a tierra, formando parte del cableado fijo de la instalación, de tal manera que las partes conductoras accesibles no puedan llegar a ser peligrosas, en caso de defecto del aislamiento principal. La toma tierra es de color amarillo y verde en la mayoría de los países, y verde en los Estados Unidos, Canadá y Japón.

Class I: Light fittings in which protection against electric shocks does not depend solely on the mains insulation, but instead contain an extra safety measure in the form of a circuit from the accessible conductive parts with an grounded protective conductor forming part of the installation's fixed wiring, so that the accessible conductive parts do not become dangerous should there be a defect in the mains insulation. Ground conductor is coloured green&yellow in most countries, and just green in the U.S., Canada and Japan.



Class II: Dispositivo de Clase II o aparato con doble aislamiento eléctrico es uno que ha sido diseñado de tal forma que no requiere una toma a tierra de seguridad eléctrica. El requisito básico es que un fallo simple no puede dar lugar a tensiones peligrosas que puedan causar una descarga eléctrica. Esto se consigue mediante dos capas de material aislante rodeando las partes con tensiones peligrosas o utilizando un aislamiento reforzado.

Class II: A Class II or double insulated electrical appliance is one which has been designed in such a way that it does not require a safety connection to electrical ground. The basic requirement is that no single failure can result in dangerous voltage becoming exposed so that it might cause an electric shock and that this is achieved without relying on an earthed metal casing. This is achieved having two layers of insulating material surrounding live parts or by using reinforced insulation.



Class III: Un aparato de Clase III está diseñado para ser alimentado por una fuente de alimentación SELV (por sus siglas en inglés: "Separated or Safety Extra-Low Voltage"). La tensión de una fuente de SELV es lo suficientemente baja para que, en condiciones normales, una persona puede entrar en contacto con ella sin correr el riesgo de descarga eléctrica. Por tanto, no es necesario incorporar la seguridad que llevan los aparatos de Clase I y Clase II. Para el cumplimiento de los dispositivos médicos la Clase III no se considera suficiente para su protección.

Class III: A Class III appliance is designed to be supplied from a separated/safety extra-low voltage (SELV) power source. The voltage from a SELV supply is low enough that under normal conditions a person can safely come into contact with it without risk of electrical shock. The extra safety features built into Class I and Class II appliances are therefore not required. For medical devices compliance with Class III is not considered sufficient protection.

CONDICIONES DE GARANTÍA

WARRANTY CONDITIONS

Kohl Lighting S.L. garantiza sus luminarias, así como los equipos que distribuye.

1- Los productos de Kohl Lighting S.L. están garantizados contra cualquier defecto de fabricación (componentes y mano de obra) durante un periodo de dos años a partir de la fecha de compra, a menos que se indique otra fecha.

2- En razón de esta garantía, sólo incumbe a Kohl Lighting S.L. la obligación de reparar o reemplazar el producto o la pieza reconocidos como defectuosos y devueltos a Kohl Lighting S.L.

3- Las reclamaciones por posibles incidencias como que el producto se entregue deteriorado, averiado, equivocado, o por cualquier otra causa susceptible de reclamación, se tratarán de la siguiente forma:

- Siempre deberá devolverse adjuntando copia de la factura de compra.

- El comprador podrá solicitar la devolución del importe en el plazo de 7 días posteriores a la recepción del pedido. Si bien deberá satisfacer gastos directos de devolución y en su caso, indemnizar los desperfectos del producto (según ley del 15/1/96 número 7/1996 del comercio minorista).

- Si por el contrario desea la sustitución del producto, el cliente deberá remitir el mismo a Kohl Lighting S.L. en el mismo plazo de 7 días, y una vez recibido, se enviará un producto en perfecto estado.

4- Toda devolución de producto invocando la garantía debe ser previamente aceptada por Kohl Lighting S.L. En todas las devoluciones el cliente se pondrá en contacto telefónico y proporcionará un número de avería y/o devolución. Dicho producto defectuoso se devolverá con el precinto de garantía intacto, en su embalaje original con sus equipos, cables y demás elementos que tuviesen en el momento de su compra y con su fallo correspondiente. Deberá ir acompañado de ese número de devolución previamente dado.

GARANTÍA DE SATISFACCIÓN:

Se podrá renunciar a la compra en un plazo máximo de 7 días, a contar desde el día de recepción de la mercancía, y la compra deberá retornarse con su embalaje original completo y en perfecto estado. Para cualquier controversia en la interpretación o ejecución que se suscite, las partes se someten, con renuncia del fuero que pueda corresponderles, a los juzgados y tribunales de la ciudad del comprador. Las devoluciones deberán ser enviadas junto con el original de la hoja de devolución, debidamente cumplimentado, que acompaña al albarán.

Las devoluciones deben remitirse a la siguiente dirección: **Partida Madrigueres Sud, 63A Naves 1-4, 03700 Dénia, (Alicante)**

Respecto a devoluciones de mercancía que no se encuentre defectuosa, se deben tener en cuenta las siguientes particularidades:

- En general no se aceptarán devoluciones de aquellos productos cuya compra se haya realizado bajo pedido confirmado y productos que hayan quedado descatalogados.

- La devolución del importe se efectuará mediante abono. Para proceder al abono de un producto deberá llegar en perfectas condiciones y con todos sus accesorios.

- Los abonos sólo procederán una vez la mercancía sea aceptada por nuestro servicio de Asistencia Técnica.

- En las devoluciones a criterio del cliente se abonará el importe de la compra exceptuando los gastos de envío.

- Kohl Lighting S.L. se reserva el derecho abonar a una cantidad inferior en caso de que el material no llegue en perfectas condiciones o con todos sus accesorios.

5- El plazo de garantía comienza a partir de la fecha de emisión de factura, no pudiendo ser ampliado en ningún caso por sustitución de un componente en una reparación o cambio.

6- La pérdida o deterioro durante el transporte por agencia no es responsabilidad de Kohl Lighting S.L.

Existen fabricantes y marcas que ofrecen su garantía directamente. Los teléfonos de contacto y procedimiento de asistencia serían facilitados en caso de necesidad.

CLAÚSULAS DE ANULACIÓN DE LA GARANTÍA:

- Incorrecta utilización, manipulación o mantenimiento por parte del Cliente de un equipo, luminaria o componente.

- Incorrecta reparación, modificación o ampliación por parte del Cliente de una luminaria o un equipo.

- Deterioro, eliminación u ocultación, por parte del Cliente, de la etiqueta identificativa de Kohl Lighting S.L.

Es decir, no se aceptará ningún material dañado, sin embalaje o con muestras evidentes de una manipulación incorrecta.

LA GARANTÍA NO CUBRE:

Quedan excluidos de toda garantía los defectos y deterioros producidos por hechos externos, accidentes, principalmente accidentes eléctricos, por desgaste y por utilización no conforme a las instrucciones.

Kohl Lighting S.L. no se responsabiliza de los errores o roturas producidas en el envío del producto. En caso de defecto o rotura no asumida por parte del departamento de atención técnica, se procederá a la devolución del producto a portes debidos.

Estas condiciones de garantía no afectan a los derechos estatutarios del consumidor amparados por su legislación vigente nacional aplicable.

HOJAS DE RECLAMACIÓN:

De acuerdo con el art. 1 del RD 5/1997 14 Enero, existen hojas de reclamación a disposición de nuestros clientes en el domicilio social de la empresa.

Kohl Lighting S.L. guarantees its fixtures and distributed gears.

1- Kohl Lighting S.L. products are guaranteed against defects in workmanship (parts and labor) for a period of two years from the date of purchase, unless other date indicated.

2- Due to this guarantee, the incumbent of Kohl Lighting S.L. is the obligation to repair or replace the product or part recognized as defective and returned to Kohl Lighting S.L..

3- Claims for incidents as the product is delivered damaged, broken, wrong, or any other cause shall be treated as follows:

- There will always be returned enclosing a copy of the invoice.
- The buyer may request a refund within 7 days of the receipt of the order. While it must satisfy direct cost of returning and where appropriate, compensate the damage to the product (Spanish Act of 15/1/96 number 7/1996 retail).
- If instead the replacement of the product is requested, the customer must submit them to Kohl Lighting S.L. within 7 days, and once received, the product will be sent in perfect conditions.

4- Any return of product invoking this guarantee must be previously accepted by Kohl, all returns to be governed by the following points:

- The customer will call the customer service of Kohl Lighting S.L., which will provide a number of breakdown and / or return.
- The defective product will be returned with the warranty seal intact, in their original packaging with their ballasts, cables and other items they had at the time of the purchase and corresponding failure. It must be accompanied by the return number.

SATISFACTION GUARANTEE:

The Customer may return the merchandise within a period of 7 days starting from the day of receipt, and it must be accompanied by the original packaging and in perfect condition. Any dispute regarding the interpretation or execution that may arise, the parties hereby waiving of jurisdiction that may apply, the courts of the city of the buyer. The returns should be sent with the original return sheet, duly completed, accompanying by the delivery note.

Returns must be sent to the following address: **Partida Madrigueres Sud, 63A Naves 1-4, 03700 Dénia, (Alicante)**

Regarding returns of merchandise that is not defective, you should consider the following features:

- In general, no returns of products whose purchase was made on confirmed order and products that have been discontinued will be accepted.
- The refund will be by a credit note. To proceed to the payment the product should arrive in perfect condition and with all accessories.
- The payments will only proceed once merchandise is accepted by our Technical Support Department. For returns which are up to the customer the amount of the purchase excluding shipping costs will be paid.
- Kohl Lighting S.L. reserves the right to pay a lower amount if the material does not arrive in perfect condition and with all accessories.

5- The warranty period starts from the date of invoice Kohl Lighting S.L. and cannot be extended in any way by replacing a component in a repair or exchange.

6- Loss or damage during the transport is not responsibility of Kohl Lighting S.L.

There are manufacturers and brands that offer their warranty directly. Contact phone number and assistance would be provided if necessary.

CLAUSES OF CANCELLATION OF WARRANTY:

- Improper use, handling or maintenance by the Customer of a gear, lighting fixture or a component.
 - Improper repair, modification or extension by the Customer of a lighting fixture or a gear.
 - Impairment, disposal or concealment by the Customer of the identification label of Kohl Lighting S.L.
- This meaning that no returns without original packaging or with obvious signs of improper manipulation will be accepted.

NOT COVERED:

Excluded from any warranty are the defects and damage caused by external events, accidents, electrical accidents mainly due to wear out and use not in accordance with the instructions of Kohl.

Kohl Lighting S.L. is not responsible for errors or breakages during the shipping of the product. In case of returns not assumed by our Technical Support Department, they shall be sent back by due freight.

These warranty conditions do not affect consumer's statutory rights protected by national legislation applicable.

LEAVES OF CLAIM:

According to Spanish art. 1 RD 5/1997 14, there are complaint forms available to our Customers at the registered office of the company.



Kohl Lighting S.L. se reserva el derecho de reproducción total o parcial de este catálogo como propietario del Copyright.

Todos los datos, croquis e imágenes están actualizados el día de la impresión, sin embargo, debido al continuo desarrollo y mejora de los productos, Kohl Lighting se reserva el derecho de modificarlos sin previo aviso.

Kohl Lighting S.L. reserves the right to reproduce total or partially this catalogue as Copyright owner. All data, sketches and pictures are up to date at the day of print, nevertheless, due to continuous product development and improvement, Kohl Lighting reserves the right to alter them without prior notice.

Kohl Lighting

Copyright © 2017

Fecha de impresión / Print date

Marzo / March 2018

Director de arte / Art Director

Bernardo Palomares

Diseño y maquetación / Design and layout

Isabel Crespo

Paula Cunha