



Kohl
Lighting

www.kohl-lighting.com



Partida Madrigueres Sud 63A, Naves 1-4
03700 Dénia (Alicante) Spain
Tel: 965 753 083
info@kohl-lighting.com

www.kohl-lighting.com

ÍNDICE POR REFERENCIAS

REFERENCE INDEX

■ K20123	54	■ K50257	31	■ K50504	14	■ K53301	42
■ K50100	74	■ K50258	31	■ K50505	15	■ K53302	42
■ K50110	71	■ K50260	32	■ K50506	20	■ K53305	43
■ K50111	71	■ K50261	32	■ K50600	50	■ K53306	43
■ K50112	72	■ K50262	32	■ K50601	50	■ K53307	43
■ K50113	72	■ K50263	32	■ K50700	62	■ K55001	88
■ K50125	76	■ K50264	32	■ K50701	62	■ K55002	88
■ K50126	76	■ K50265	32	■ K50710	66	■ K55003	88
■ K50130	73	■ K50266	32	■ K50711	66	■ K55004	89
■ K50131	73	■ K50270	34	■ K50712	66	■ K55006	89
■ K50132	74	■ K50271	34	■ K50715	67	■ K55007	89
■ K50140	70	■ K50272	34	■ K50716	67	■ K55008	88
■ K50141	70	■ K50273	34	■ K50717	67	■ KAC50500	24
■ K50150	56	■ K50274	34	■ K50800	64	■ KAC50501	24
■ K50151	56	■ K50275	34	■ K50801	64	■ KAC50502	24
■ K50152	56	■ K50276	34	■ K50802	64	■ KAC50503	24
■ K50200	36	■ K50300	60	■ K52100	84	■ KAC50506	24
■ K50201	36	■ K50301	60	■ K52200	84	■ KAC50150	57
■ K50202	36	■ K50302	60	■ K52300	85	■ KAC50152	57
■ K50203	36	■ K50303	60	■ K52301	85	■ KAC50300	61
■ K50206	36	■ K50310	46	■ K52400	80	■ KAC50301	61
■ K50210	37	■ K50311	46	■ K52401	80	■ KAC50302	61
■ K50211	37	■ K50312	46	■ K52500	82	■ KAC50303	61
■ K50212	37	■ K50313	46	■ K52501	82	■ KACFLEX1	94
■ K50220	38	■ K50315	47	■ K52502	82	■ KACFLEX2	94
■ K50221	38	■ K50316	47	■ K52600	86	■ KACRGB1	95
■ K50222	38	■ K50317	47	■ K52601	86	■ KACRGB2	95
■ K50223	38	■ K50318	47	■ K52602	86	■ KACRGB3	95
■ K50224	38	■ K50400	52	■ K52603	86	■ KACRGB4	95
■ K50225	38	■ K50401	52	■ K52604	86	■ KACRGB5	95
■ K50226	38	■ K50405	48	■ K52605	86	■ KACRGBW1	95
■ K50230	40	■ K50406	48	■ K53100	44	■ KD55100	94
■ K50231	40	■ K50407	48	■ K53101	44	■ KD55101	94
■ K50232	40	■ K50410	53	■ K53102	44	■ KDFLEX1	94
■ K50233	40	■ K50411	53	■ K53105	45	■ KLB	77
■ K50250	30	■ K50415	49	■ K53106	45	■ KP50001	92
■ K50251	30	■ K50416	49	■ K53107	45	■ KP50002	92
■ K50252	30	■ K50500	18	■ K53280.DW	63	■ KP50003	92
■ K50253	30	■ K50501	22	■ K53270	58	■ KP50004	92
■ K50255	31	■ K50502	10	■ K53271	59		
■ K50256	31	■ K50503	12	■ K53300	42		

ÍNDICE EN ORDEN ALFABÉTICO

ALPHABETIC ORDER INDEX

■ BOLETUS	80	■ LIM SQUARE	47
■ CHESS (595x595 mm)	18	■ LUMIFLEX CC 28	90
■ CHESS (1195x295 mm)	20	■ LUXO	56
■ CHESS (1195x595 mm)	22	■ LUXO ACCESORIES	57
■ CIRQUE	52	■ MAILBOX	84
■ CORNER	53	■ MIRANDA	44
■ DAISY	74	■ MIRANDA SQUARE	45
■ DARA	60	■ MOON	71
■ DARA ACCESORIES	61	■ NOON	64
■ DASH	73	■ OZONE	72
■ DAWN	70	■ PREMIUM	54
■ DETEK	63	■ REBECCA	58
■ DIP IP 65	72	■ REBECCA SQUARE	59
■ DISC	36	■ SASHA	66
■ DISC SQUARE	37	■ SAT ROUND	76
■ DISC SQUARE SURFACE	40	■ SAT SQUARE	76
■ DISC SURFACE	38	■ SERENA	67
■ DOT	73	■ SHOWFLEX CV RGB ECO	91
■ ELITE (595x595 mm)	14	■ SHOWFLEX CV RGBW	91
■ ELITE (1195x595 mm)	16	■ STORM	86
■ FLEX CC BLANCO DINÁMIC	91	■ SUN	70
■ FLEX CV 15	90	■ TRIM	30
■ FLEX CV ECO	90	■ TRIM SQUARE	31
■ FLEX PRO CC 20	90	■ TRIM SQUARE SURFACE	34
■ FOCUS	74	■ TRIM SURFACE	32
■ HAMMER ROUND	85	■ TINA ROUND	48
■ HAMMER SQUARE	85	■ TINA SQUARE	49
■ HUNTER	85	■ TINY ROUND	50
■ KLB	75	■ TINY SQUARE	50
■ LACUS	42	■ TOWER	82
■ LACUS SQUARE	43	■ VENUS	71
■ LASSO	62	■ WINNER (595x595 mm)	10
■ LIM ROUND	46	■ WINNER (1195x595 mm)	12

- PANEL LED / LED PANEL
- LED INTEGRADO / INTEGRATED LED
- GU10
- EXTERIOR / OUTDOOR
- TIRAS DE LED / LED STRIPS

PANEL LED / LED PANEL

10 WINNER
REF. K50502



12 WINNER
REF. K50503

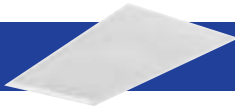

14 ELITE
REF. K50504

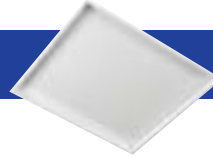

16 ELITE
REF. K50505



30 TRIM
REF. K50250/1/2/3



NEW

31 TRIM SQUARE
REF. K50255/6/7/8



NEW

LED INTEGRADO / INTEGRATED LED

38 DISC SURFACE
REF. K50220/1/2/3/4/5/6



40 DISC SQUARE
SURFACE
REF. K50230/1/2/3



42 LACUS
REF. K53300/1/2



NEW

43 LACUS SQUARE
REF. K53305/6/7



NEW

48 TINA ROUND
REF. K50405/6/7



49 TINA SQUARE
REF. K50415/6

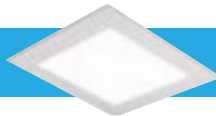

50 TINY ROUND
REF. K50600



50 TINY SQUARE
REF. K50601



58 REBECCA
REF. K53270



59 REBECCA
SQUARE
REF. K53271



60 DARA
REF. K50300/1/2/3



62 LASSO
REF. K50700/1



18 CHESS
REF. K50500

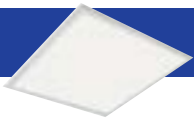

20 CHESS
REF. K50506



22 CHESS
REF. K50501



**24 ACCESORIOS
ACCESSORIES**



32 TRIM SURFACE
REF. K50260/1/2/3/4/5/6



NEW

**34 TRIM SQUARE
SURFACE**
REF. K50270/1/2/3/4/5/6



NEW

36 DISC
REF. K50200/1/2/3/6



37 DISC SQUARE
REF. K50210/1/2



44 MIRANDA
REF. K53100/1/2



**45 MIRANDA
SQUARE**
REF. K53105/6/7



46 LIM ROUND
REF. K50310/1/2/3



47 LIM SQUARE
REF. K50315/6/7/8



52 CIRQUE
REF. K50400/1



53 CORNER
REF. K50410/1



54 PREMIUM
REF. K20123



56 LUXO
REF. K50150/1/2
REF. K50153 **IP65**



NEW

64 NOON
REF. K50800/1/2



NEW

63 DETEK
REF. K53265/6/7



NEW

66 SASHA
REF. K50710/1/2



67 SERENA
REF. K50715/6/7



GU10

70 **SUN**
REF. K50140



70 **DAWN**
REF. K50141



73 **DOT**
REF. K50130



73 **DASH**
REF. K50131



74 **DAISY**
REF. K50132



74 **FOCUS**
REF. K50100



80 **BOLETUS**
REF. K52400/1



82 **TOWER**
REF. K52500/1/2



84 **MAILBOX**
REF. K52100



EXTERIOR / OUTDOOR

TIRAS DE LED / LED STRIPS

90 **TIRAS DE LED**
LED STRIPS



92 **PERFILES**
PROFILES



INFORMACIÓN TÉCNICA / TECHNICAL INFORMATION

98 **MEDIDAS DE CORTE / CUT OUT**

99 **SÍMBOLOS / SYMBOLS**

100 **FOTOMETRÍAS / PHOTOMETRICS**

71 MOON
REF. K50110



71 VENUS
REF. K50111



72 OZONE
REF. K50112



72 DIP IP 65
REF. K50113



76 SAT ROUND
REF. K50126



76 SAT SQUARE
REF. K50125



77 KLB



84 HUNTER
REF. K52200



85 HAMMER ROUND
REF. K52300



85 HAMMER SQUARE
REF. K52301



86 STORM
REF. K52600/1/2/3/4/5



94 EQUIPOS DRIVERS



94 REGULADORES DIMMERS



95 ACCESORIOS ACCESSORIES



102 GRADO DE PROTECCIÓN IP / IP DEGREE OF PROTECTION

103 CLASES DE PROTECCIÓN CONTRA CHOQUES ELÉCTRICOS / PROTECTION CLASSES AGAINST ELECTRIC SHOCKS

104 CONDICIONES DE GARANTÍA / WARRANTY CONDITIONS

PANEL LED

INTEGRATED

LED

GU10

OUTDOOR

LED STRIPS

TECHNICAL

INFORMATION

WINNER

REF. K50502

37W



IP44

IP20



DIM

900

mA

CRI

≥80

35000

DRIVER

INC.



3 YEARS WARRANTY

Blanco / White 3000K

K50502.W.OP.3K	3589 lm	OP	NO DIM
K50502.W.OP.3K.DA	3589 lm	OP	DALI
K50502.W.OP.3K.PU	3589 lm	OP	PUSH
K50502.W.OP.3K.D1	3589 lm	OP	1..10V
K50502.W.MP.3K	3441 lm	MP	NO DIM
K50502.W.MP.3K.DA	3441 lm	MP	DALI
K50502.W.MP.3K.PU	3441 lm	MP	PUSH
K50502.W.MP.3K.D1	3441 lm	MP	1..10V
K50502.W.SK.3K	2010 lm	SK	NO DIM
K50502.W.SK.3K.DA	2010 lm	SK	DALI
K50502.W.SK.3K.PU	2010 lm	SK	PUSH
K50502.W.SK.3K.D1	2010 lm	SK	1..10V

3,92 Kg

Medidas / Measures:

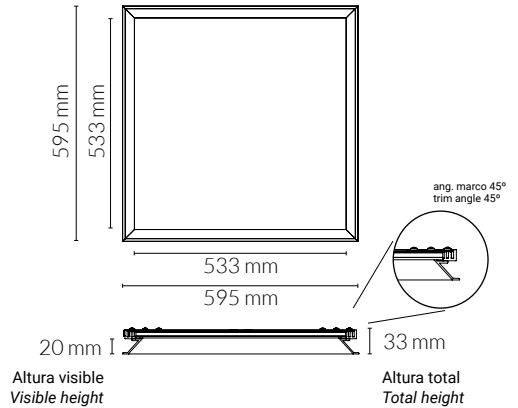

Blanco / White 4000K

K50502.W.OP.4K	3885 lm	OP	NO DIM
K50502.W.OP.4K.DA	3885 lm	OP	DALI
K50502.W.OP.4K.PU	3885 lm	OP	PUSH
K50502.W.OP.4K.D1	3885 lm	OP	1..10V
K50502.W.MP.4K	3700 lm	MP	NO DIM
K50502.W.MP.4K.DA	3700 lm	MP	DALI
K50502.W.MP.4K.PU	3700 lm	MP	PUSH
K50502.W.MP.4K.D1	3700 lm	MP	1..10V
K50502.W.SK.4K	2176 lm	SK	NO DIM
K50502.W.SK.4K.DA	2176 lm	SK	DALI
K50502.W.SK.4K.PU	2176 lm	SK	PUSH
K50502.W.SK.4K.D1	2176 lm	SK	1..10V

Opciones de difusor / Optic cover options:

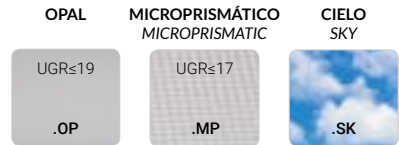

Opciones de acabado / Finish options:

Blanco / White 6000K

K50502.W.OP.6K	4000 lm	OP	NO DIM
K50502.W.OP.6K.DA	4000 lm	OP	DALI
K50502.W.OP.6K.PU	4000 lm	OP	PUSH
K50502.W.OP.6K.D1	4000 lm	OP	1..10V
K50502.W.MP.6K	3774 lm	MP	NO DIM
K50502.W.MP.6K.DA	3774 lm	MP	DALI
K50502.W.MP.6K.PU	3774 lm	MP	PUSH
K50502.W.MP.6K.D1	3774 lm	MP	1..10V
K50502.W.SK.6K	2240 lm	SK	NO DIM
K50502.W.SK.6K.DA	2240 lm	SK	DALI
K50502.W.SK.6K.PU	2240 lm	SK	PUSH
K50502.W.SK.6K.D1	2240 lm	SK	1..10V

Colores - Colors	
	Negro - Black .BK
	Gris - Grey .GY
	Azul - Blue .BL
	Aqua - Aqua .AQ
	Rojo - Red .RE
	Rosa - Pink .PI
	Flamenco - Flamingo .FL
	Naranja - Orange .OR
	Verde - Green .GR
	Oro - Gold .G

El color por defecto es blanco. En caso de querer otro, sustituir ".W" por la referencia del acabado deseado.
The default color is white. If you want another one, replace ".W" by desired color reference.



○ Blanco / White **3000K**

K50503.W.OP.3K	5616 lm	OP	NO DIM
K50503.W.OP.3K.DA	5616 lm	OP	DALI
K50503.W.OP.3K.PU	5616 lm	OP	PUSH
K50503.W.OP.3K.D1	5616 lm	OP	1..10V
K50503.W.MP.3K	5328 lm	MP	NO DIM
K50503.W.MP.3K.DA	5328 lm	MP	DALI
K50503.W.MP.3K.PU	5328 lm	MP	PUSH
K50503.W.MP.3K.D1	5328 lm	MP	1..10V
K50503.W.SK.3K	3145 lm	SK	NO DIM
K50503.W.SK.3K.DA	3145 lm	SK	DALI
K50503.W.SK.3K.PU	3145 lm	SK	PUSH
K50503.W.SK.3K.D1	3145 lm	SK	1..10V

○ Blanco / White **4000K**

K50503.W.OP.4K	6264 lm	OP	NO DIM
K50503.W.OP.4K.DA	6264 lm	OP	DALI
K50503.W.OP.4K.PU	6264 lm	OP	PUSH
K50503.W.OP.4K.D1	6264 lm	OP	1..10V
K50503.W.MP.4K	6048 lm	MP	NO DIM
K50503.W.MP.4K.DA	6048 lm	MP	DALI
K50503.W.MP.4K.PU	6048 lm	MP	PUSH
K50503.W.MP.4K.D1	6048 lm	MP	1..10V
K50503.W.SK.4K	3508 lm	SK	NO DIM
K50503.W.SK.4K.DA	3508 lm	SK	DALI
K50503.W.SK.4K.PU	3508 lm	SK	PUSH
K50503.W.SK.4K.D1	3508 lm	SK	1..10V

○ Blanco / White **6000K**

K50503.W.OP.6K	6494 lm	OP	NO DIM
K50503.W.OP.6K.DA	6494 lm	OP	DALI
K50503.W.OP.6K.PU	6494 lm	OP	PUSH
K50503.W.OP.6K.D1	6494 lm	OP	1..10V
K50503.W.MP.6K	6192 lm	MP	NO DIM
K50503.W.MP.6K.DA	6192 lm	MP	DALI
K50503.W.MP.6K.PU	6192 lm	MP	PUSH
K50503.W.MP.6K.D1	6192 lm	MP	1..10V
K50503.W.SK.6K	3637 lm	SK	NO DIM
K50503.W.SK.6K.DA	3637 lm	SK	DALI
K50503.W.SK.6K.PU	3637 lm	SK	PUSH
K50503.W.SK.6K.D1	3637 lm	SK	1..10V

4,33 Kg

Medidas / Measures:

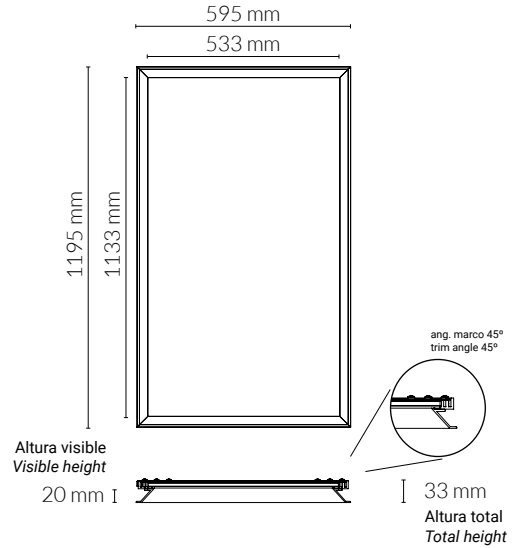

Opciones de difusor / Optic cover options:

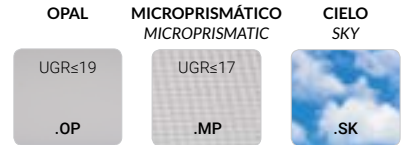

Opciones de acabado / Finish options:







Colores - Colors	
Negro - Black	.BK
Gris - Grey	.GY
Azul - Blue	.BL
Aqua - Aqua	.AQ
Rojo - Red	.RE
Rosa - Pink	.PI
Flamenco - Flamingo	.FL
Naranja - Orange	.OR
Verde - Green	.GR
Oro - Gold	.G

El color por defecto es blanco. En caso de querer otro, sustituir ".W" por la referencia del acabado deseado.
The default color is white. If you want another one, replace ".W" by desired color reference.



ELITE

REF. K50504

37W  IP44 OUTSIDE IP20 INSIDE  DIM OPTIONAL 900 mA CRI ≥80  35000 DRIVER INC.   CE 

○ Blanco / White **3000K**

K50504.W.OP.3K	3589 lm	OP	NO DIM
K50504.W.OP.3K.DA	3589 lm	OP	DALI
K50504.W.OP.3K.PU	3589 lm	OP	PUSH
K50504.W.OP.3K.D1	3589 lm	OP	1..10V
K50504.W.MP.3K	3441 lm	MP	NO DIM
K50504.W.MP.3K.DA	3441 lm	MP	DALI
K50504.W.MP.3K.PU	3441 lm	MP	PUSH
K50504.W.MP.3K.D1	3441 lm	MP	1..10V
K50504.W.SK.3K	2010 lm	SK	NO DIM
K50504.W.SK.3K.DA	2010 lm	SK	DALI
K50504.W.SK.3K.PU	2010 lm	SK	PUSH
K50504.W.SK.3K.D1	2010 lm	SK	1..10V

 4,70 Kg

Medidas / Measures:

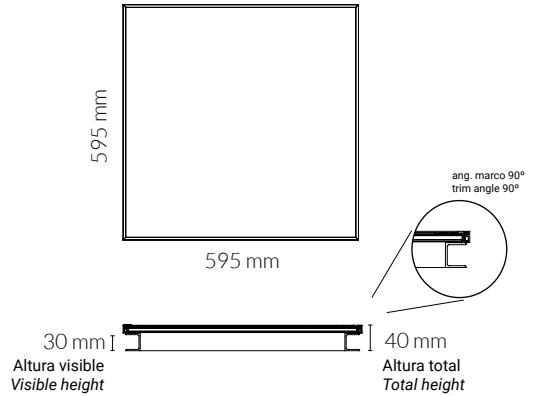

○ Blanco / White **4000K**

K50504.W.OP.4K	3885 lm	OP	NO DIM
K50504.W.OP.4K.DA	3885 lm	OP	DALI
K50504.W.OP.4K.PU	3885 lm	OP	PUSH
K50504.W.OP.4K.D1	3885 lm	OP	1..10V
K50504.W.MP.4K	3700 lm	MP	NO DIM
K50504.W.MP.4K.DA	3700 lm	MP	DALI
K50504.W.MP.4K.PU	3700 lm	MP	PUSH
K50504.W.MP.4K.D1	3700 lm	MP	1..10V
K50504.W.SK.4K	2176 lm	SK	NO DIM
K50504.W.SK.4K.DA	2176 lm	SK	DALI
K50504.W.SK.4K.PU	2176 lm	SK	PUSH
K50504.W.SK.4K.D1	2176 lm	SK	1..10V

Opciones de difusor / Optic cover options:

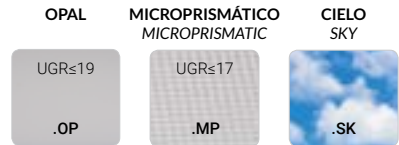

Opciones de acabado / Finish options:

Colores - Colors	
 Negro - Black	.BK
 Gris - Grey	.GY
 Azul - Blue	.BL
 Aqua - Aqua	.AQ
 Rojo - Red	.RE
 Rosa - Pink	.PI
 Flamenco - Flamingo	.FL
 Naranja - Orange	.OR
 Verde - Green	.GR
 Oro - Gold	.G

El color por defecto es blanco. En caso de querer otro, sustituir "W" por la referencia del acabado deseado.
The default color is white. If you want another one, replace "W" by desired color reference.

○ Blanco / White **6000K**

K50504.W.OP.6K	4000 lm	OP	NO DIM
K50504.W.OP.6K.DA	4000 lm	OP	DALI
K50504.W.OP.6K.PU	4000 lm	OP	PUSH
K50504.W.OP.6K.D1	4000 lm	OP	1..10V
K50504.W.MP.6K	3774 lm	MP	NO DIM
K50504.W.MP.6K.DA	3774 lm	MP	DALI
K50504.W.MP.6K.PU	3774 lm	MP	PUSH
K50504.W.MP.6K.D1	3774 lm	MP	1..10V
K50504.W.SK.6K	2240 lm	SK	NO DIM
K50504.W.SK.6K.DA	2240 lm	SK	DALI
K50504.W.SK.6K.PU	2240 lm	SK	PUSH
K50504.W.SK.6K.D1	2240 lm	SK	1..10V



ELITE

REF. K50505

72W



IP44

IP20



DIM

1800

CRI

≥80

35000

DRIVER

INC.



CE

3 YEARS WARRANTY

Blanco / White 3000K

K50505.W.OP.3K	5616 lm	OP	NO DIM
K50505.W.OP.3K.DA	5616 lm	OP	DALI
K50505.W.OP.3K.PU	5616 lm	OP	PUSH
K50505.W.OP.3K.D1	5616 lm	OP	1..10V
K50505.W.MP.3K	5328 lm	MP	NO DIM
K50505.W.MP.3K.DA	5328 lm	MP	DALI
K50505.W.MP.3K.PU	5328 lm	MP	PUSH
K50505.W.MP.3K.D1	5328 lm	MP	1..10V
K50505.W.SK.3K	3145 lm	SK	NO DIM
K50505.W.SK.3K.DA	3145 lm	SK	DALI
K50505.W.SK.3K.PU	3145 lm	SK	PUSH
K50505.W.SK.3K.D1	3145 lm	SK	1..10V

Blanco / White 4000K

K50505.W.OP.4K	6264 lm	OP	NO DIM
K50505.W.OP.4K.DA	6264 lm	OP	DALI
K50505.W.OP.4K.PU	6264 lm	OP	PUSH
K50505.W.OP.4K.D1	6264 lm	OP	1..10V
K50505.W.MP.4K	6048 lm	MP	NO DIM
K50505.W.MP.4K.DA	6048 lm	MP	DALI
K50505.W.MP.4K.PU	6048 lm	MP	PUSH
K50505.W.MP.4K.D1	6048 lm	MP	1..10V
K50505.W.SK.4K	3508 lm	SK	NO DIM
K50505.W.SK.4K.DA	3508 lm	SK	DALI
K50505.W.SK.4K.PU	3508 lm	SK	PUSH
K50505.W.SK.4K.D1	3508 lm	SK	1..10V

Blanco / White 6000K

K50505.W.OP.6K	6494 lm	OP	NO DIM
K50505.W.OP.6K.DA	6494 lm	OP	DALI
K50505.W.OP.6K.PU	6494 lm	OP	PUSH
K50505.W.OP.6K.D1	6494 lm	OP	1..10V
K50505.W.MP.6K	6192 lm	MP	NO DIM
K50505.W.MP.6K.DA	6192 lm	MP	DALI
K50505.W.MP.6K.PU	6192 lm	MP	PUSH
K50505.W.MP.6K.D1	6192 lm	MP	1..10V
K50505.W.SK.6K	3637 lm	SK	NO DIM
K50505.W.SK.6K.DA	3637 lm	SK	DALI
K50505.W.SK.6K.PU	3637 lm	SK	PUSH
K50505.W.SK.6K.D1	3637 lm	SK	1..10V

8,90 Kg

Medidas / Measures:

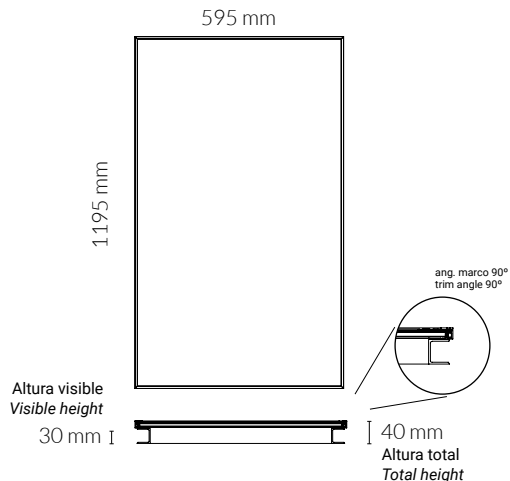

Opciones de difusor / Optic cover options:

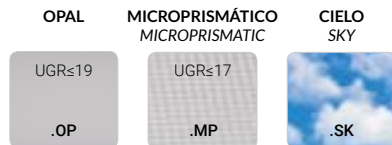

Opciones de acabado / Finish options:

Colores - Colors	
Negro - Black	.BK
Gris - Grey	.GY
Azul - Blue	.BL
Aqua - Aqua	.AQ
Rojo - Red	.RE
Rosa - Pink	.PI
Flamenco - Flamingo	.FL
Naranja - Orange	.OR
Verde - Green	.GR
Oro - Gold	.G

El color por defecto es blanco. En caso de querer otro, sustituir ".W" por la referencia del acabado deseado.
The default color is white. If you want another one, replace ".W" by desired color reference.



CHESS

REF. K50500

37W



IP44

IP20



DIM

900

mA

CRI

≥80

35000

DRIVER

INC.



CE

3 YEARS

WARRANTY

○ Blanco / White **3000K**

K50500.W.OP.3K	3589 lm	OP	NO DIM
K50500.W.OP.3K.DA	3589 lm	OP	DALI
K50500.W.OP.3K.PU	3589 lm	OP	PUSH
K50500.W.OP.3K.D1	3589 lm	OP	1..10V
K50500.W.MP.3K	3441 lm	MP	NO DIM
K50500.W.MP.3K.DA	3441 lm	MP	DALI
K50500.W.MP.3K.PU	3441 lm	MP	PUSH
K50500.W.MP.3K.D1	3441 lm	MP	1..10V
K50500.W.SK.3K	2010 lm	SK	NO DIM
K50500.W.SK.3K.DA	2010 lm	SK	DALI
K50500.W.SK.3K.PU	2010 lm	SK	PUSH
K50500.W.SK.3K.D1	2010 lm	SK	1..10V

4,08 Kg

Medidas / Measures:

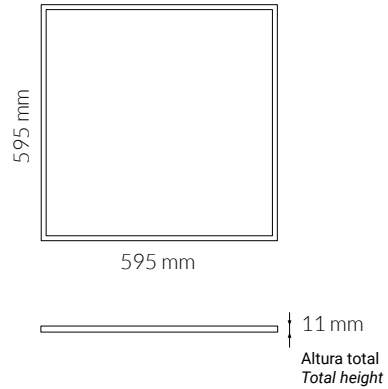

○ Blanco / White **4000K**

K50500.W.OP.4K	3885 lm	OP	NO DIM
K50500.W.OP.4K.DA	3885 lm	OP	DALI
K50500.W.OP.4K.PU	3885 lm	OP	PUSH
K50500.W.OP.4K.D1	3885 lm	OP	1..10V
K50500.W.MP.4K	3700 lm	MP	NO DIM
K50500.W.MP.4K.DA	3700 lm	MP	DALI
K50500.W.MP.4K.PU	3700 lm	MP	PUSH
K50500.W.MP.4K.D1	3700 lm	MP	1..10V
K50500.W.SK.4K	2176 lm	SK	NO DIM
K50500.W.SK.4K.DA	2176 lm	SK	DALI
K50500.W.SK.4K.PU	2176 lm	SK	PUSH
K50500.W.SK.4K.D1	2176 lm	SK	1..10V

Opciones de difusor / Optic cover options:

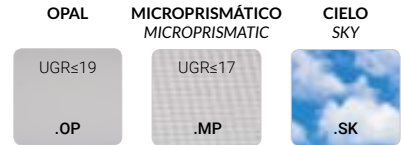

○ Blanco / White **6000K**

K50500.W.OP.6K	4000 lm	OP	NO DIM
K50500.W.OP.6K.DA	4000 lm	OP	DALI
K50500.W.OP.6K.PU	4000 lm	OP	PUSH
K50500.W.OP.6K.D1	4000 lm	OP	1..10V
K50500.W.MP.6K	3774 lm	MP	NO DIM
K50500.W.MP.6K.DA	3774 lm	MP	DALI
K50500.W.MP.6K.PU	3774 lm	MP	PUSH
K50500.W.MP.6K.D1	3774 lm	MP	1..10V
K50500.W.SK.6K	2240 lm	SK	NO DIM
K50500.W.SK.6K.DA	2240 lm	SK	DALI
K50500.W.SK.6K.PU	2240 lm	SK	PUSH
K50500.W.SK.6K.D1	2240 lm	SK	1..10V



CHESS

REF. K50506

37W



IP44

IP20



DIM

900

mA

CRI

≥80

35000

DRIVER

INC.



CE

3 YEARS

WARRANTY

○ Blanco / White **3000K**

K50506.W.OP.3K	3589 lm	OP	NO DIM
K50506.W.OP.3K.DA	3589 lm	OP	DALI
K50506.W.OP.3K.PU	3589 lm	OP	PUSH
K50506.W.OP.3K.D1	3589 lm	OP	1..10V
K50506.W.SK.3K	2153 lm	SK	NO DIM
K50506.W.SK.3K.DA	2153 lm	SK	DALI
K50506.W.SK.3K.PU	2153 lm	SK	PUSH
K50506.W.SK.3K.D1	2153 lm	SK	1..10V

○ Blanco / White **4000K**

K50506.W.OP.4K	3885 lm	OP	NO DIM
K50506.W.OP.4K.DA	3885 lm	OP	DALI
K50506.W.OP.4K.PU	3885 lm	OP	PUSH
K50506.W.OP.4K.D1	3885 lm	OP	1..10V
K50506.W.SK.4K	2331 lm	SK	NO DIM
K50506.W.SK.4K.DA	2331 lm	SK	DALI
K50506.W.SK.4K.PU	2331 lm	SK	PUSH
K50506.W.SK.4K.D1	2331 lm	SK	1..10V

○ Blanco / White **6000K**

K50506.W.OP.6K	4000 lm	OP	NO DIM
K50506.W.OP.6K.DA	4000 lm	OP	DALI
K50506.W.OP.6K.PU	4000 lm	OP	PUSH
K50506.W.OP.6K.D1	4000 lm	OP	1..10V
K50506.W.SK.6K	2400 lm	SK	NO DIM
K50506.W.SK.6K.DA	2400 lm	SK	DALI
K50506.W.SK.6K.PU	2400 lm	SK	PUSH
K50506.W.SK.6K.D1	2400 lm	SK	1..10V

4,16 Kg

Medidas / Measures:

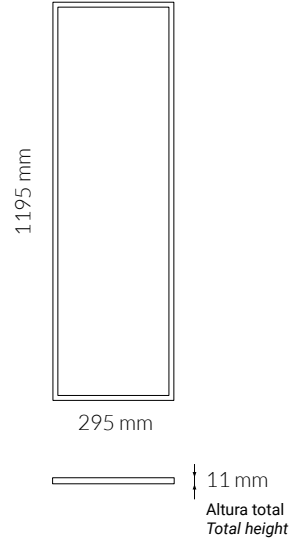

Opciones de difusor / Optic cover options:

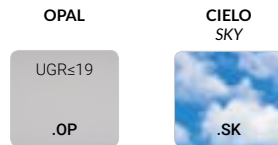



CHESS

REF. K50501

72W



IP44

OUTSIDE

IP20

INSIDE

DIM

OPTIONAL

900

mA

CRI

≥80

35000

DRIVER

INC.



3 YEARS WARRANTY

○ Blanco / White **3000K**

K50501.W.OP.3K	5616 lm	OP	NO DIM
K50501.W.OP.3K.DA	5616 lm	OP	DALI
K50501.W.OP.3K.PU	5616 lm	OP	PUSH
K50501.W.OP.3K.D1	5616 lm	OP	1..10V
K50501.W.MP.3K	5328 lm	MP	NO DIM
K50501.W.MP.3K.DA	5328 lm	MP	DALI
K50501.W.MP.3K.PU	5328 lm	MP	PUSH
K50501.W.MP.3K.D1	5328 lm	MP	1..10V
K50501.W.SK.3K	3145 lm	SK	NO DIM
K50501.W.SK.3K.DA	3145 lm	SK	DALI
K50501.W.SK.3K.PU	3145 lm	SK	PUSH
K50501.W.SK.3K.D1	3145 lm	SK	1..10V

7,90 Kg

Medidas / Measures:

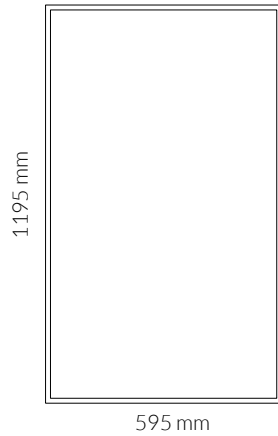

○ Blanco / White **4000K**

K50501.W.OP.4K	6264 lm	OP	NO DIM
K50501.W.OP.4K.DA	6264 lm	OP	DALI
K50501.W.OP.4K.PU	6264 lm	OP	PUSH
K50501.W.OP.4K.D1	6264 lm	OP	1..10V
K50501.W.MP.4K	6048 lm	MP	NO DIM
K50501.W.MP.4K.DA	6048 lm	MP	DALI
K50501.W.MP.4K.PU	6048 lm	MP	PUSH
K50501.W.MP.4K.D1	6048 lm	MP	1..10V
K50501.W.SK.4K	3508 lm	SK	NO DIM
K50501.W.SK.4K.DA	3508 lm	SK	DALI
K50501.W.SK.4K.PU	3508 lm	SK	PUSH
K50501.W.SK.4K.D1	3508 lm	SK	1..10V



Opciones de difusor / Optic cover options:

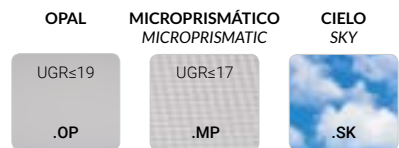

○ Blanco / White **6000K**

K50501.W.OP.6K	6494 lm	OP	NO DIM
K50501.W.OP.6K.DA	6494 lm	OP	DALI
K50501.W.OP.6K.PU	6494 lm	OP	PUSH
K50501.W.OP.6K.D1	6494 lm	OP	1..10V
K50501.W.MP.6K	6192 lm	MP	NO DIM
K50501.W.MP.6K.DA	6192 lm	MP	DALI
K50501.W.MP.6K.PU	6192 lm	MP	PUSH
K50501.W.MP.6K.D1	6192 lm	MP	1..10V
K50501.W.SK.6K	3637 lm	SK	NO DIM
K50501.W.SK.6K.DA	3637 lm	SK	DALI
K50501.W.SK.6K.PU	3637 lm	SK	PUSH
K50501.W.SK.6K.D1	3637 lm	SK	1..10V



ACCESORIOS PARA TECHOS NO MODULARES

NON-MODULAR CEILING ACCESSORIES

Accesorios para WINNER, ELITE y CHESS / Accessories for WINNER, ELITE & CHESS:

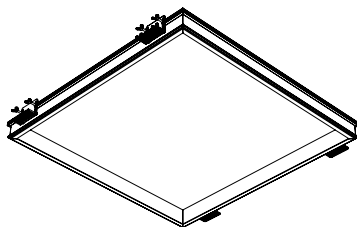

EMPOTRADO SIN MARCO - TRIMLESS		
KAC50502.TR	595x595 mm	
KAC50503.TR	1195x595 mm	
KAC50506.TR	1195x295 mm	1,12 Kg

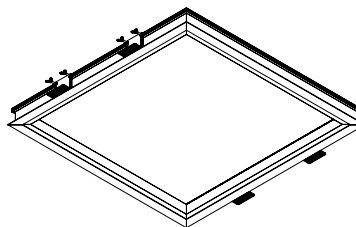

EMPOTRADO CON MARCO - RECESSED WITH FRAME		
KAC50502.RF	595x595 mm	
KAC50503.RF	1195x595 mm	
KAC50506.RF	1195x295 mm	1,12 Kg



PINZAS PARA EMPOTRAR CLAMPS FOR RECESSING		
KAC50500.RF	595x595 mm	4 unidades/units
KAC50501.RF	1195x595 mm 1195x295 mm	6 unidades/units

Accesorios sólo para CHESS / Accessories just for CHESS:

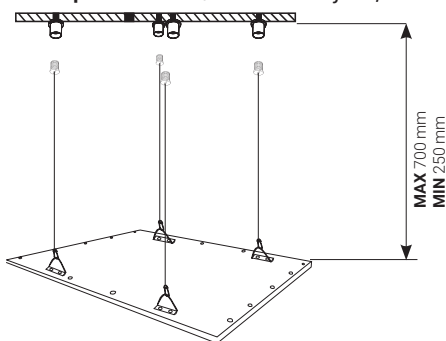

COLGANTE - PENDANT		
KAC50500.PN	595x595 mm	0,70 Kg
KAC50501.PN	1195x595 mm 1195x295 mm	1,24 Kg

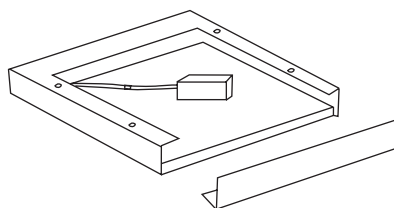

SUPERFICIE - SURFACE		
KAC50500.SR	595x595 mm	
KAC50501.SR	1195x595 mm	
KAC50506.SR	1195x295 mm	1,12 Kg

FOTOGRAFÍAS ACCESORIOS

ACCESSORIES PICTURES

Pinzas para empotrar el CHESS, WINNER Y ELITE
Clamps for recessing CHESS, WINNER & ELITE



Accesorio para poner el CHESS en superficie
Accessory for attaching CHESS on surface

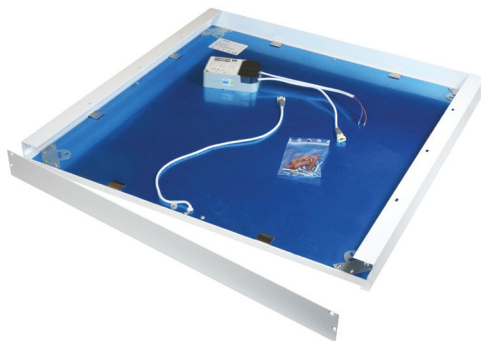

Accesorio para hacer colgante el CHESS
Accessory for converting CHESS in pendant

PANEL CONTROLADOR DE CAMBIO DE TEMPERATURA DE COLOR

REMOTE CONTROL BOARD FOR COLOUR TEMPERATURE CHANGE



Blanco dinámico/ *Dinamic white*

2900K - 5900K

3000K
Blanco cálido
Warm white

3399 lm

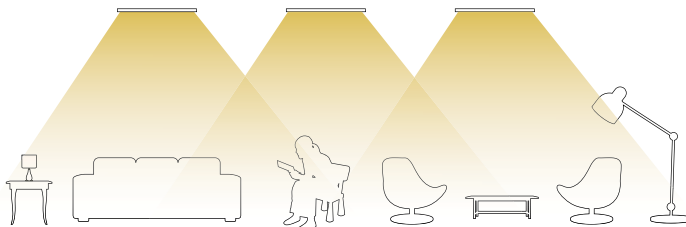

4000K
Blanco natural
Natural white

4202 lm

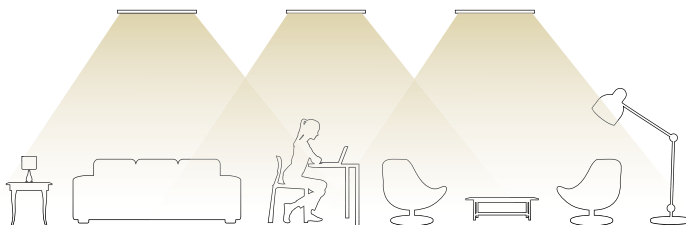

6000K
Blanco frío
Cool white

3655 lm

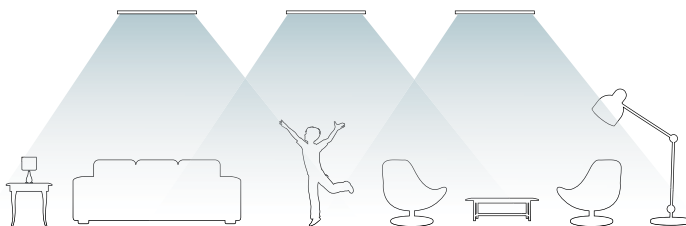

MANDO A DISTANCIA INCLUIDO
REMOTE CONTROL INCLUDED

WINNER	K50502.W.OP.WT	40W · OPAL · 2900K-5900K · 585x585 mm
	K50503.W.OP.WT	55W · OPAL · 2900K-5900K · 1195x585 mm
ELITE	K50504.W.OP.WT	40W · OPAL · 2900K-5900K · 595x595 mm
	K50505.W.OP.WT	55W · OPAL · 2900K-5900K · 1195x595 mm
CHESS	K50500.W.OP.WT	40W · OPAL · 2900K-5900K · 595x595 mm
	K50501.W.OP.WT	55W · OPAL · 2900K-5900K · 1195x595 mm

3000K



4000K



6000K



PANEL LED

INTEGRATED

LED

PARA OPCIONES DE REGULACIÓN CONSULTAR PRECIOS
CONSULT THE PRICES FOR DIMMABLE OPTIONS

GU10

OUTDOOR

LED STRIPS

TECHNICAL

INFORMATION

TRIM

REF. K50250/1/2/3



IP 32



CRI ≥80

15000

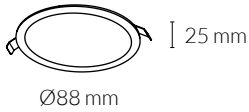

8W 230mA Ø75mm 0,14Kg

<input type="radio"/>	K50250.W.3K	678 lm	3000K	Blanco/White
<input type="radio"/>	K50250.W.4K	683 lm	4000K	Blanco/White

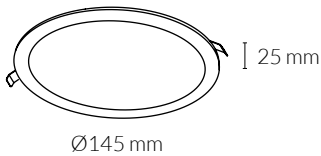

16W 220mA Ø130mm 0,32Kg

<input type="radio"/>	K50251.W.3K	1483 lm	3000K	Blanco/White
<input type="radio"/>	K50251.W.4K	1491 lm	4000K	Blanco/White

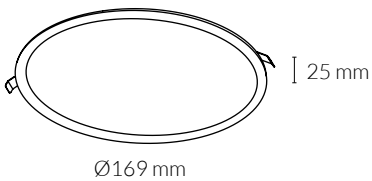

22W 210mA Ø155mm 0,46Kg

<input type="radio"/>	K50252.W.3K	2332 lm	3000K	Blanco/White
<input type="radio"/>	K50252.W.4K	2338 lm	4000K	Blanco/White

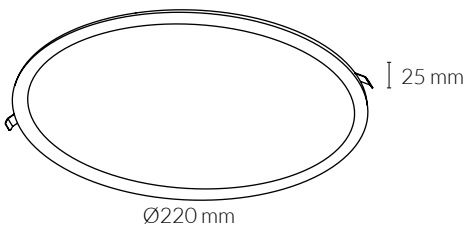

30W 450mA Ø200mm 0,70Kg

<input type="radio"/>	K50253.W.3K	3291 lm	3000K	Blanco/White
<input type="radio"/>	K50253.W.4K	3296 lm	4000K	Blanco/White

TRIM SQUARE

REF. K50255/6/7/8

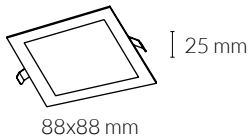

8W 230mA 75x75mm 0,18Kg

- K50255.W.3K 682 lm 3000K Blanco/White
- K50255.W.4K 687 lm 4000K Blanco/White

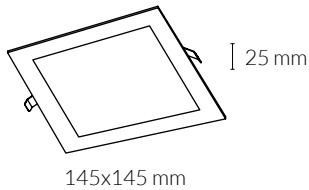

16W 220mA 130x130mm 0,41Kg

- K50256.W.3K 1490 lm 3000K Blanco/White
- K50256.W.4K 1496 lm 4000K Blanco/White

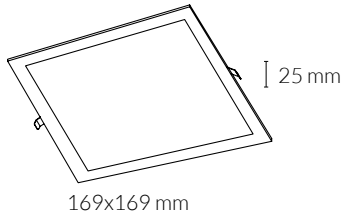

22W 210mA 155x155mm 0,55Kg

- K50257.W.3K 2335 lm 3000K Blanco/White
- K50257.W.4K 2342 lm 4000K Blanco/White

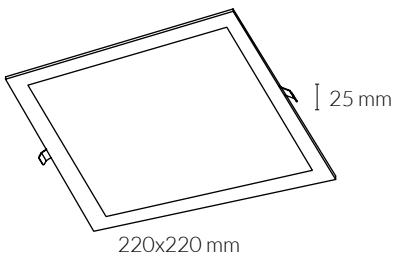

30W 450mA 200x200mm 0,82Kg

- K50258.W.3K 3295 lm 3000K Blanco/White
- K50258.W.4K 3302 lm 4000K Blanco/White

TRIM SURFACE

REF. K50260/1/2/3/4/5/6



8W 230mA 0,19Kg

<input type="radio"/>	K50260.W.3K	678 lm	3000K	Blanco/White
<input type="radio"/>	K50260.W.4K	683 lm	4000K	Blanco/White

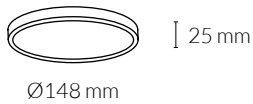

16W 220mA 0,41Kg

<input type="radio"/>	K50261.W.3K	1483 lm	3000K	Blanco/White
<input type="radio"/>	K50261.W.4K	1491 lm	4000K	Blanco/White

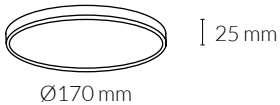

22W 210mA 0,53Kg

<input type="radio"/>	K50262.W.3K	2332 lm	3000K	Blanco/White
<input type="radio"/>	K50262.W.4K	2338 lm	4000K	Blanco/White

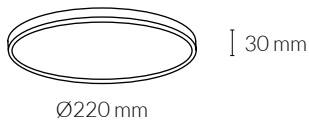

30W 450mA 0,84Kg

<input type="radio"/>	K50263.W.3K	3291 lm	3000K	Blanco/White
<input type="radio"/>	K50263.W.4K	3296 lm	4000K	Blanco/White

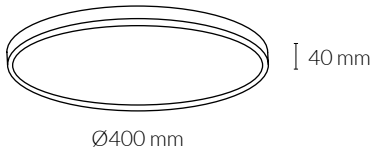

36W 600mA

○	K50264.W.3K	3373 lm	3000K	Blanco/White
○	K50264.W.4K	3381 lm	4000K	Blanco/White

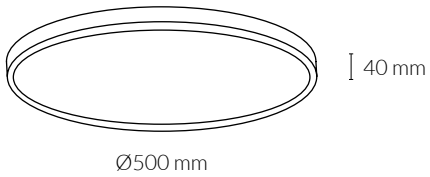

48W 1200mA

○	K50265.W.3K	4701 lm	3000K	Blanco/White
○	K50265.W.4K	4712 lm	4000K	Blanco/White

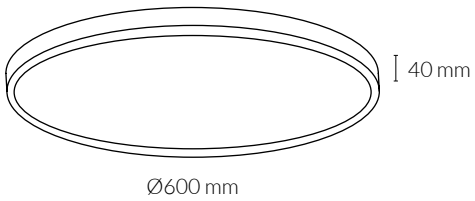

56W 900mA

○	K50266.W.3K	5417 lm	3000K	Blanco/White
○	K50266.W.4K	5426 lm	4000K	Blanco/White



TRIM SQUARE SURFACE

REF. K50270/1/2/3/4/5/6

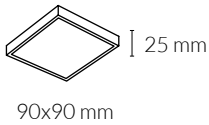

8W 230mA  0,22Kg

<input type="radio"/>	K50270.W.3K	682 lm	3000K	Blanco/White
<input type="radio"/>	K50270.W.4K	687 lm	4000K	Blanco/White

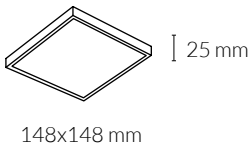

16W 220mA  0,48Kg

<input type="radio"/>	K50271.W.3K	1490 lm	3000K	Blanco/White
<input type="radio"/>	K50271.W.4K	1496 lm	4000K	Blanco/White

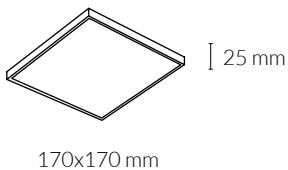

22W 210mA  0,57Kg

<input type="radio"/>	K50272.W.3K	2335 lm	3000K	Blanco/White
<input type="radio"/>	K50272.W.4K	2342 lm	4000K	Blanco/White

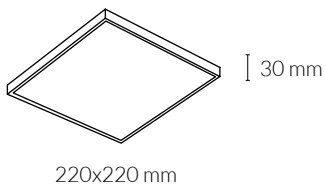

30W 450mA  0,970Kg

<input type="radio"/>	K50273.W.3K	3295 lm	3000K	Blanco/White
<input type="radio"/>	K50273.W.4K	3302 lm	4000K	Blanco/White

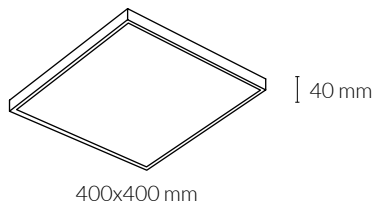

36W 600mA

○	K50274.W.3K	3380 lm	3000K	Blanco/White
○	K50274.W.4K	3387 lm	4000K	Blanco/White

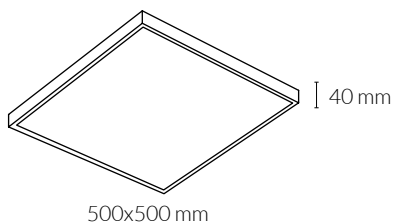

48W 1200mA

○	K50275.W.3K	4709 lm	3000K	Blanco/White
○	K50275.W.4K	4721 lm	4000K	Blanco/White

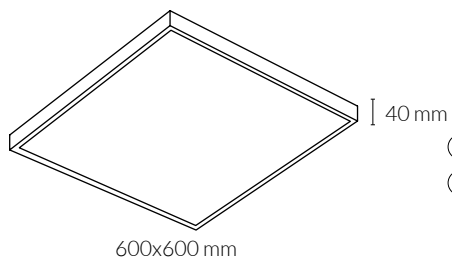

56W 900mA

○	K50276.W.3K	5426 lm	3000K	Blanco/White
○	K50276.W.4K	5439 lm	4000K	Blanco/White



DISC

REF. K50200/1/2/3/6

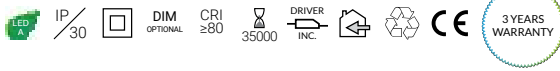

4,08 Kg

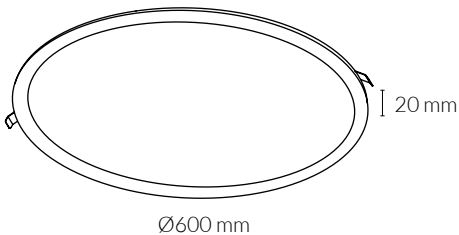
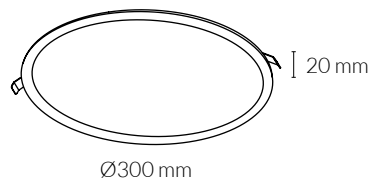
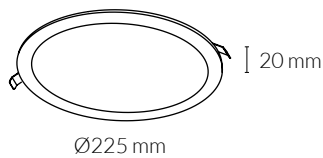
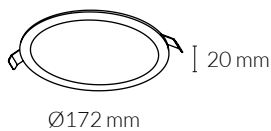
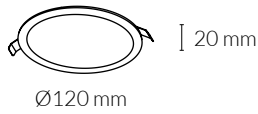

8W 300mA Ø108mm 0,22 Kg

○	K50200.W.3K	360 lm	3000K	Blanco/White
○	K50200.W.4K	464 lm	4000K	Blanco/White
●	K50200.GY.3K	360 lm	3000K	Gris/Grey
●	K50200.GY.4K	464 lm	4000K	Gris/Grey

12W 300mA Ø152mm 0,34 Kg

○	K50201.W.3K	768 lm	3000K	Blanco/White
○	K50201.W.4K	780 lm	4000K	Blanco/White
●	K50201.GY.3K	768 lm	3000K	Gris/Grey
●	K50201.GY.4K	780 lm	4000K	Gris/Grey

20W 300mA Ø205mm 0,50 Kg

○	K50202.W.3K	1500 lm	3000K	Blanco/White
○	K50202.W.4K	1560 lm	4000K	Blanco/White
●	K50202.GY.3K	1500 lm	3000K	Gris/Grey
●	K50202.GY.4K	1560 lm	4000K	Gris/Grey

24W 300mA Ø280mm 0,88 Kg

○	K50203.W.3K	1800 lm	3000K	Blanco/White
○	K50203.W.4K	1872 lm	4000K	Blanco/White
●	K50203.GY.3K	1800 lm	3000K	Gris/Grey
●	K50203.GY.4K	1872 lm	4000K	Gris/Grey

56W 900mA Ø580mm 3,58 Kg

○	K50206.W.3K	3976 lm	3000K	Blanco/White
○	K50206.W.4K	4032 lm	4000K	Blanco/White
●	K50206.GY.3K	3976 lm	3000K	Gris/Grey
●	K50206.GY.4K	4032 lm	4000K	Gris/Grey

DISC SQUARE

REF. K50210/1/2



IP 30



DIM
OPTIONAL

CRI
≥80

35000

DRIVER
INC.



CE

3 YEARS
WARRANTY



8W 300mA 100x100mm 0,24 Kg

	K50210.W.3K	360 lm	3000K	Blanco/White
	K50210.W.4K	464 lm	4000K	Blanco/White
	K50210.GY.3K	360 lm	3000K	Gris/Grey
	K50210.GY.4K	464 lm	4000K	Gris/Grey

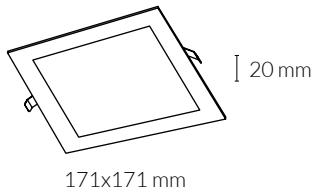

12W 300mA 155x155mm 0,40 Kg

	K50211.W.3K	768 lm	3000K	Blanco/White
	K50211.W.4K	780 lm	4000K	Blanco/White
	K50211.GY.3K	768 lm	3000K	Gris/Grey
	K50211.GY.4K	780 lm	4000K	Gris/Grey

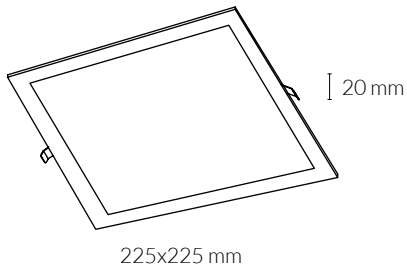

20W 300mA 200x200mm 0,60 Kg

	K50212.W.3K	1500 lm	3000K	Blanco/White
	K50212.W.4K	1560 lm	4000K	Blanco/White
	K50212.GY.3K	1500 lm	3000K	Gris/Grey
	K50212.GY.4K	1560 lm	4000K	Gris/Grey

DISC SURFACE

REF. K50220/1/2/3/4/5/6





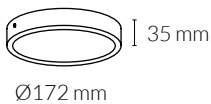

8W 300mA  0,28 Kg

	K50220.W.3K	360 lm	3000K	Blanco/White
	K50220.W.4K	464 lm	4000K	Blanco/White
	K50220.GY.3K	360 lm	3000K	Gris/Grey
	K50220.GY.4K	464 lm	4000K	Gris/Grey







12W 300mA  0,38 Kg

	K50221.W.3K	768 lm	3000K	Blanco/White
	K50221.W.4K	780 lm	4000K	Blanco/White
	K50221.GY.3K	768 lm	3000K	Gris/Grey
	K50221.GY.4K	780 lm	4000K	Gris/Grey



20W 300mA  0,60 Kg

	K50222.W.3K	1500 lm	3000K	Blanco/White
	K50222.W.4K	1560 lm	4000K	Blanco/White
	K50222.GY.3K	1500 lm	3000K	Gris/Grey
	K50222.GY.4K	1560 lm	4000K	Gris/Grey

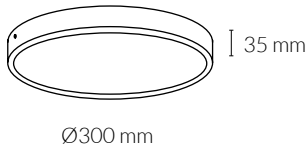

24W 300mA  1,06Kg

	K50223.W.3K	1800 lm	3000K	Blanco/White
	K50223.W.4K	1872 lm	4000K	Blanco/White
	K50223.GY.3K	1800 lm	3000K	Gris/Grey
	K50223.GY.4K	1872 lm	4000K	Gris/Grey

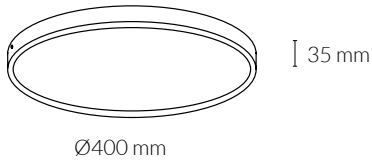

36W 700mA  1,70 Kg

	K50224.W.3K	2700 lm	3000K	Blanco/White
	K50224.W.4K	2808 lm	4000K	Blanco/White
	K50224.GY.3K	2700 lm	3000K	Gris/Grey
	K50224.GY.4K	2808 lm	4000K	Gris/Grey

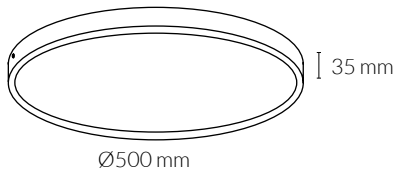

48W 1200mA  2,96 Kg

	K50225.W.3K	3552 lm	3000K	Blanco/White
	K50225.W.4K	3600 lm	4000K	Blanco/White
	K50225.GY.3K	3552 lm	3000K	Gris/Grey
	K50225.GY.4K	3600 lm	4000K	Gris/Grey

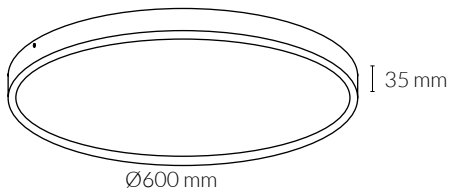

56W 900mA  4,06 Kg

	K50226.W.3K	3976 lm	3000K	Blanco/White
	K50226.W.4K	4032 lm	4000K	Blanco/White
	K50226.GY.3K	3976 lm	3000K	Gris/Grey
	K50226.GY.4K	4032 lm	4000K	Gris/Grey

DISC SQUARE SURFACE

REF. K50230/1/2/3



IP 30



DIM OPTIONAL

CRI ≥80

35000

DRIVER INC.



CE

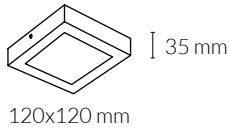

8W 300mA 0,32 Kg

	K50230.W.3K	360 lm	3000K	Blanco/White
	K50230.W.4K	464 lm	4000K	Blanco/White
	K50230.GY.3K	360 lm	3000K	Gris/Grey
	K50230.GY.4K	464 lm	4000K	Gris/Grey

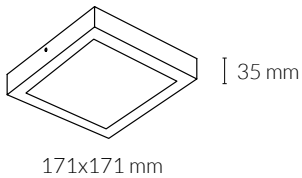

12W 300mA 0,46 Kg

	K50231.W.3K	768 lm	3000K	Blanco/White
	K50231.W.4K	780 lm	4000K	Blanco/White
	K50231.GY.3K	768 lm	3000K	Gris/Grey
	K50231.GY.4K	780 lm	4000K	Gris/Grey

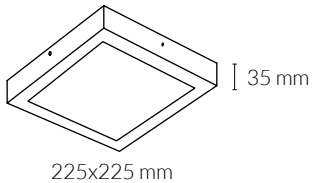

20W 300mA 0,80 Kg

	K50232.W.3K	1500 lm	3000K	Blanco/White
	K50232.W.4K	1560 lm	4000K	Blanco/White
	K50232.GY.3K	1500 lm	3000K	Gris/Grey
	K50232.GY.4K	1560 lm	4000K	Gris/Grey

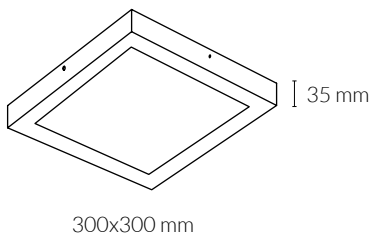

24W 300mA 1,28 Kg

	K50233.W.3K	1800 lm	3000K	Blanco/White
	K50233.W.4K	1872 lm	4000K	Blanco/White
	K50233.GY.3K	1800 lm	3000K	Gris/Grey
	K50233.GY.4K	1872 lm	4000K	Gris/Grey



LACUS

REF. K53300/1/2



IP/44



DIM
OPTIONAL

CRI
≥80

35000

DRIVER
INC.



CE

3 YEARS
WARRANTY

NEW

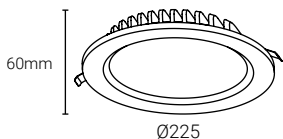
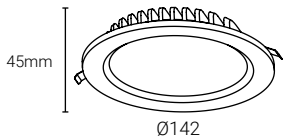
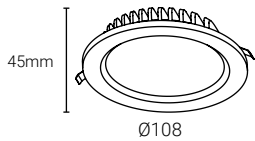

7W 350mA Ø90mm 0,28 Kg

- K53300.BK.3K 3000K 686 lm Negro/Black
- K53300.BK.4K 4000K 707 lm Negro/Black
- K53300.W.3K 3000K 686 lm Blanco/White
- K53300.W.4K 4000K 707 lm Blanco/White

15W 350mA Ø120mm 0,40 Kg

- K53301.BK.3K 3000K 1470 lm Negro/Black
- K53301.BK.4K 4000K 1515 lm Negro/Black
- K53301.W.3K 3000K 1470 lm Blanco/White
- K53301.W.4K 4000K 1515 lm Blanco/White

30W 350mA Ø190mm 0,54 Kg

- K53302.BK.3K 3000K 2940 lm Negro/Black
- K53302.BK.4K 4000K 3030 lm Negro/Black
- K53302.W.3K 3000K 2940 lm Blanco/White
- K53302.W.4K 4000K 3030 lm Blanco/White

LACUS SQUARE

REF. K53305/6/7



IP 44



DIM
OPTIONAL

CRI
≥80

35000

DRIVER
INC.



CE

3 YEARS
WARRANTY

NEW

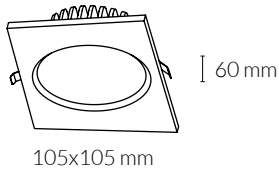

7W 350mA Ø90mm

○	K53305.W.3K	686 lm	3000K	Blanco/White
○	K53305.W.4K	707 lm	4000K	Blanco/White
●	K53305.BK.3K	686 lm	3000K	Negro/Black
●	K53305.BK.4K	707 lm	4000K	Negro/Black

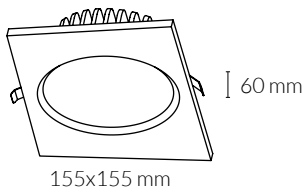

15W 350mA Ø135mm

○	K53306.W.3K	1470 lm	3000K	Blanco/White
○	K53306.W.4K	1515 lm	4000K	Blanco/White
●	K53306.BK.3K	1470 lm	3000K	Negro/Black
●	K53306.BK.4K	1515 lm	4000K	Negro/Black

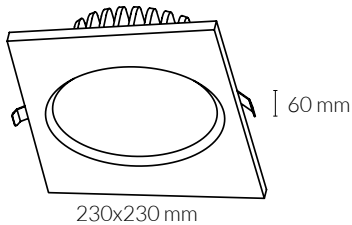

30W 350mA Ø210mm

○	K53307.W.3K	2940 lm	3000K	Blanco/White
○	K53307.W.4K	3030 lm	4000K	Blanco/White
●	K53307.BK.3K	2940 lm	3000K	Negro/Black
●	K53307.BK.4K	3030 lm	4000K	Negro/Black

MIRANDA

REF. K53100/1/2



IP 43



DIM
OPTIONAL

CRI
≥80

35000

DRIVER
INC.



3 YEARS
WARRANTY

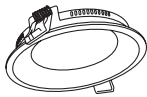

27 mm

Ø120 mm

8W

200mA



Ø109mm



0,30 Kg



K53100.W.3K

720 lm

3000K

Blanco/White



K53100.W.4K

800 lm

4000K

Blanco/White

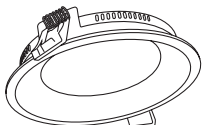

27 mm

Ø172 mm

15W

350mA



Ø159mm



0,48 Kg



K53101.W.3K

1350 lm

3000K

Blanco/White



K53101.W.4K

1500 lm

4000K

Blanco/White

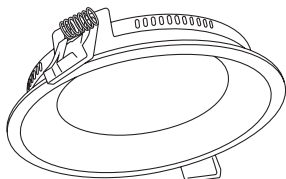

27 mm

Ø227 mm

22W

600mA



Ø214mm



0,48 Kg



K53102.W.3K

1980 lm

3000K

Blanco/White



K53102.W.4K

2200 lm

4000K

Blanco/White

MIRANDA SQUARE

REF. K53105/6/7



IP 43



DIM
OPTIONAL

CRI
≥80

35000

DRIVER
INC.



CE



27 mm

120x120 mm

8W 200mA 109x109mm 0,34 Kg

- K53105.W.3K 720 lm 3000K Blanco/White
- K53105.W.4K 800 lm 4000K Blanco/White



27 mm

172x172 mm

15W 350mA 159x159mm 0,56 Kg

- K53106.W.3K 1350 lm 3000K Blanco/White
- K53106.W.4K 1500 lm 4000K Blanco/White

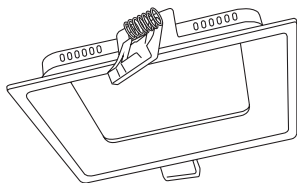

27 mm

227x227 mm

22W 600mA 214x214mm 0,92 Kg

- K53107.W.3K 1980 lm 3000K Blanco/White
- K53107.W.4K 2200 lm 4000K Blanco/White

LIM ROUND

REF. K50310/1/2/3

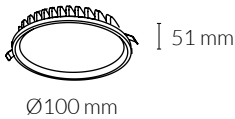

7W 350mA $\frac{dB}{dB}$ Ø86mm

○	K50310.W.3K	560 lm	3000K	Blanco/White
○	K50310.W.4K	581 lm	4000K	Blanco/White
●	K50310.BK.3K	560 lm	3000K	Negro/Black
●	K50310.BK.4K	581 lm	4000K	Negro/Black

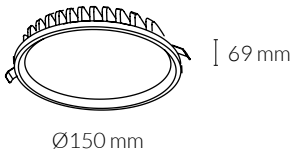

12W 350mA $\frac{dB}{dB}$ Ø136mm

○	K50311.W.3K	960 lm	3000K	Blanco/White
○	K50311.W.4K	996 lm	4000K	Blanco/White
●	K50311.BK.3K	960 lm	3000K	Negro/Black
●	K50311.BK.4K	996 lm	4000K	Negro/Black

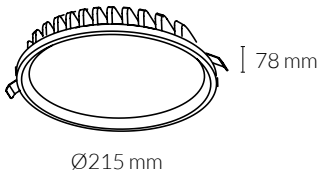

25W 700mA $\frac{dB}{dB}$ Ø201mm

○	K50312.W.3K	2000 lm	3000K	Blanco/White
○	K50312.W.4K	2075 lm	4000K	Blanco/White
●	K50312.BK.3K	2000 lm	3000K	Negro/Black
●	K50312.BK.4K	2075 lm	4000K	Negro/Black

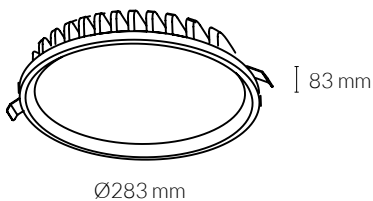

35W 900mA $\frac{dB}{dB}$ Ø266mm

○	K50313.W.3K	2800 lm	3000K	Blanco/White
○	K50313.W.4K	2905 lm	4000K	Blanco/White
●	K50313.BK.3K	2800 lm	3000K	Negro/Black
●	K50313.BK.4K	2905 lm	4000K	Negro/Black

LIM SQUARE

REF. K50315/6/7/8

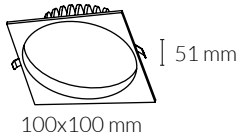
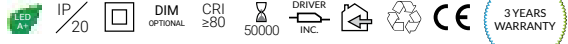

7W 350mA Ø86mm

○	K50315.W.3K	560 lm	3000K	Blanco/White
○	K50315.W.4K	581 lm	4000K	Blanco/White
●	K50315.BK.3K	560 lm	3000K	Negro/Black
●	K50315.BK.4K	581 lm	4000K	Negro/Black

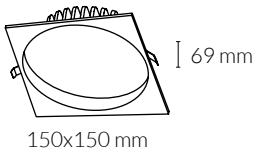

12W 350mA Ø136mm

○	K50316.W.3K	960 lm	3000K	Blanco/White
○	K50316.W.4K	996 lm	4000K	Blanco/White
●	K50316.BK.3K	960 lm	3000K	Negro/Black
●	K50316.BK.4K	996 lm	4000K	Negro/Black

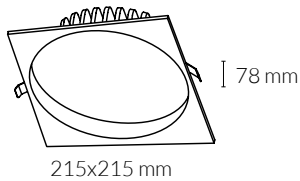

25W 700mA Ø201mm

○	K50317.W.3K	2000 lm	3000K	Blanco/White
○	K50317.W.4K	2075 lm	4000K	Blanco/White
●	K50317.BK.3K	2000 lm	3000K	Negro/Black
●	K50317.BK.4K	2075 lm	4000K	Negro/Black

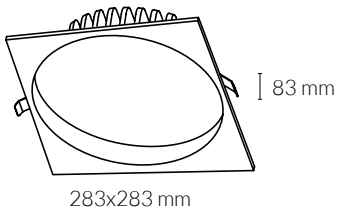

35W 700mA Ø266mm

○	K50318.W.3K	2800 lm	3000K	Blanco/White
○	K50318.W.4K	2905 lm	4000K	Blanco/White
●	K50318.BK.3K	2800 lm	3000K	Negro/Black
●	K50318.BK.4K	2905 lm	4000K	Negro/Black

TINA ROUND

REF. K50405/6/7

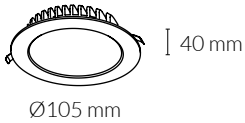
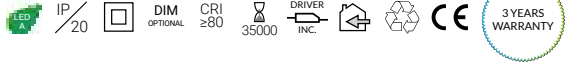

8W 300mA ϕ Ø95mm

○	K50405.W.3K	358 lm	3000K	Blanco/White
○	K50405.W.4K	459 lm	4000K	Blanco/White

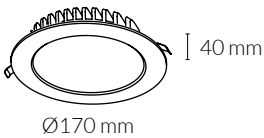

18W 300mA ϕ Ø160mm

○	K50406.W.3K	920 lm	3000K	Blanco/White
○	K50406.W.4K	1200 lm	4000K	Blanco/White

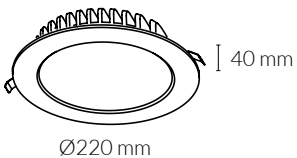

24W 300mA ϕ Ø200mm

○	K50407.W.3K	1080 lm	3000K	Blanco/White
○	K50407.W.4K	1400 lm	4000K	Blanco/White

TINA SQUARE

REF. K50415/6



IP 20



DIM
OPTIONAL

CRI
≥80

35000

DRIVER
INC.



CE

3 YEARS
WARRANTY

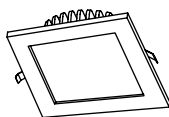

40 mm

109x109 mm

8W 300mA  98x98mm

- | | | | | |
|-----------------------|-------------|--------|-------|--------------|
| <input type="radio"/> | K50415.W.3K | 358 lm | 3000K | Blanco/White |
| <input type="radio"/> | K50415.W.4K | 459 lm | 4000K | Blanco/White |

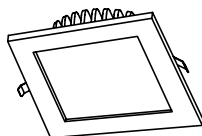

40 mm

180x180 mm

18W 300mA  170x170mm



- | | | | | |
|-----------------------|-------------|---------|-------|--------------|
| <input type="radio"/> | K50416.W.3K | 920 lm | 3000K | Blanco/White |
| <input type="radio"/> | K50416.W.4K | 1200 lm | 4000K | Blanco/White |

TINY ROUND

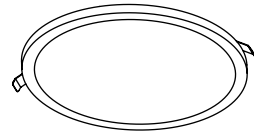
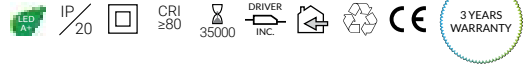
REF. K50600



Ø88x22 mm

8W 240mA  Ø75 mm  0,14 Kg



○ K50600.W.4K 720 lm 4000K Blanco/White

TINY SQUARE

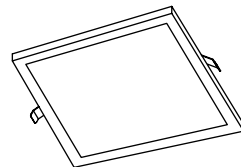
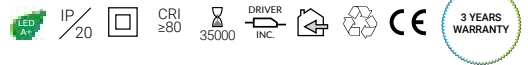
REF. K50601



88x88x22 mm

8W 240mA  Ø75 mm  0,18 Kg

○ K50601.W.4K 720 lm 4000K Blanco/White



CIRQUE

REF. K50400/1



IP/20



CRI ≥80



35000



DRIVER INC.



CE

3 YEARS WARRANTY

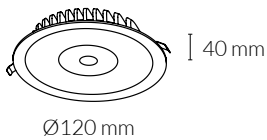

8+5W 300mA Ø110mm 0,36 Kg

- K50400.W.3K 788 lm 3000K Blanco/White
- K50400.W.4K 803 lm 4000K Blanco/White

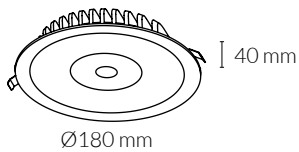

15+7W 300mA Ø170mm 0,44 Kg

- K50401.W.3K 1651 lm 3000K Blanco/White
- K50401.W.4K 1903 lm 4000K Blanco/White

CORNER

REF. K50410/1

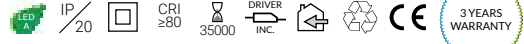

Tres modos de iluminar en tres pasos
Three lighting modes in three steps

paso 1 / step 1



paso 2 / step 2



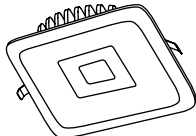

paso 3 / step 3



40 mm

120x120 mm

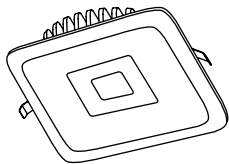

8+5W 300mA  110x110mm  0,26 Kg

- K50410.W.3K 813 lm 3000K Blanco/White
- K50410.W.4K 838 lm 4000K Blanco/White



40 mm

180x180 mm

15+7W 300mA  170x170mm  0,52 Kg

- K50411.W.3K 1771 lm 3000K Blanco/White
- K50411.W.4K 1752 lm 4000K Blanco/White

PREMIUM

REF. K20123

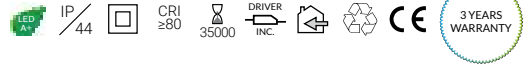

ELIGE COLOR Y FORMA DEL REFLECTOR
CHOOSE REFLECTOR COLOUR & SHAPE



FACETADO
.FC

LISO
.PL

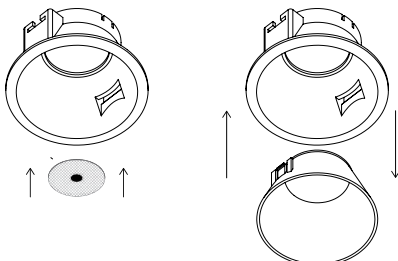
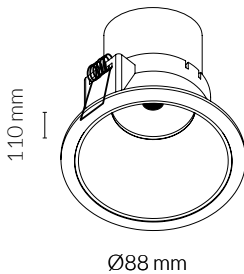

8W 200mA Ø83mm 0,38 Kg

○	K20123.W.FC.27K	697 lm	2700K	Blanco/White
○	K20123.W.PL.27K	697 lm	2700K	Blanco/White
●	K20123.BK.FC.27K	697 lm	2700K	Negro/Black
●	K20123.BK.PL.27K	697 lm	2700K	Negro/Black
○	K20123.W.FC.3K	736 lm	3000K	Blanco/White
○	K20123.W.PL.3K	736 lm	3000K	Blanco/White
●	K20123.BK.FC.3K	736 lm	3000K	Negro/Black
●	K20123.BK.PL.3K	736 lm	3000K	Negro/Black
○	K20123.W.FC.4K	774 lm	4000K	Blanco/White
○	K20123.W.PL.4K	774 lm	4000K	Blanco/White
●	K20123.BK.FC.4K	774 lm	4000K	Negro/Black
●	K20123.BK.PL.4K	774 lm	4000K	Negro/Black

PREMIUM

REF. K20123

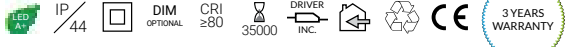

LENTES - LENSES
INCLUIDO - INCLUDED



MULTILENSES
40°
Mayor ángulo



MULTILENSES
25°
Intermedio



LUXO

REF. K50150/1/2



3 YEARS WARRANTY



8W 200mA Ø76mm 0,24 Kg

	K50150.W.3K	780 lm	3000K	Blanco/White
	K50150.W.4K	820 lm	4000K	Blanco/White
	K50150.BK.3K	780 lm	3000K	Negro/Black
	K50150.BK.4K	820 lm	4000K	Negro/Black

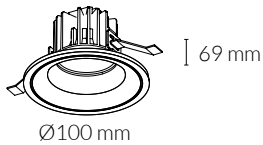

12W 300mA Ø90mm 0,28 Kg

	K50151.W.3K	1153 lm	3000K	Blanco/White
	K50151.W.4K	1165 lm	4000K	Blanco/White
	K50151.BK.3K	1153 lm	3000K	Negro/Black
	K50151.BK.4K	1165 lm	4000K	Negro/Black

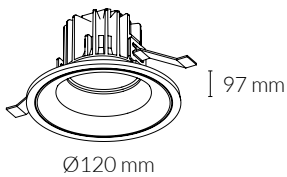

22W 500mA Ø113mm 0,52 Kg

	K50152.W.3K	1943 lm	3000K	Blanco/White
	K50152.W.4K	1953 lm	4000K	Blanco/White
	K50152.BK.3K	1943 lm	3000K	Negro/Black
	K50152.BK.4K	1953 lm	4000K	Negro/Black



IP65

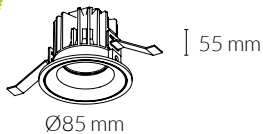

12W IP65 300mA Ø76mm 0,24 Kg



	K50153.W.3K	1153 lm	3000K	Blanco/White
	K50153.W.4K	1165 lm	4000K	Blanco/White
	K50153.BK.3K	1153 lm	3000K	Negro/Black
	K50153.BK.4K	1165 lm	4000K	Negro/Black



LUXO ACCESSORIES

REF. KAC50150/1/2

REFLECTOR

	REFLECTOR	REF.	Power
K50150 / K50151		KAC50150.D15 - KAC50150.D25 - KAC50150.D60 *	8 - 12W
K50152		KAC50152.D16 - KAC50152.D24	22 W

* Válido también para K50151 / Also valid for K50151



REBECCA

REF. K53270



IP/20



DIM
OPTIONAL

30°

350°

CRI
≥80

35000

DRIVER
INC.



3 YEARS
WARRANTY

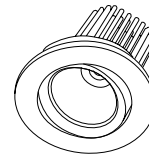

90 mm

Ø93 mm

3000K

10W

320mA

Ø80mm



0,22 Kg

○	K53270.W.D40.3K	40°	990 lm	No DIM	Blanco/White
○	K53270.W.D40.3K.PC	40°	990 lm	Phase Cut	Blanco/White
○	K53270.W.D60.3K	60°	990 lm	No DIM	Blanco/White
○	K53270.W.D60.3K.PC	60°	990 lm	Phase Cut	Blanco/White
●	K53270.SA.D40.3K	40°	990 lm	No DIM	Aluminio rallado/Striped aluminum
●	K53270.SA.D40.3K.PC	40°	990 lm	Phase Cut	Aluminio rallado/Striped aluminum
●	K53270.SA.D60.3K	60°	990 lm	No DIM	Aluminio rallado/Striped aluminum
●	K53270.SA.D60.3K.PC	60°	990 lm	Phase Cut	Aluminio rallado/Striped aluminum

4000K

10W

320mA

Ø80mm



0,22 Kg

○	K53270.W.D40.4K	40°	1010 lm	No DIM	Blanco/White
○	K53270.W.D40.4K.PC	40°	1010 lm	Phase Cut	Blanco/White
○	K53270.W.D60.4K	60°	1010 lm	No DIM	Blanco/White
○	K53270.W.D60.4K.PC	60°	1010 lm	Phase Cut	Blanco/White
●	K53270.SA.D40.4K	40°	1010 lm	No DIM	Aluminio rallado/Striped aluminum
●	K53270.SA.D40.4K.PC	40°	1010 lm	Phase Cut	Aluminio rallado/Striped aluminum
●	K53270.SA.D60.4K	60°	1010 lm	No DIM	Aluminio rallado/Striped aluminum
●	K53270.SA.D60.4K.PC	60°	1010 lm	Phase Cut	Aluminio rallado/Striped aluminum

REBECCA SQUARE

REF. K53271



IP 20



DIM OPTIONAL

30°

350°

CRI ≥80

35000

DRIVER INC.



3 YEARS WARRANTY



3000K **10W** 320mA Ø80mm 0,48 Kg

	K53271.W.D40.3K	40°	990 lm	No DIM	Blanco/White
	K53271.W.D40.3K.PC	40°	990 lm	Phase Cut	Blanco/White
	K53271.W.D60.3K	60°	990 lm	No DIM	Blanco/White
	K53271.W.D60.3K.PC	60°	990 lm	Phase Cut	Blanco/White
	K53271.SA.D40.3K	40°	990 lm	No DIM	Aluminio rallado/Striped aluminum
	K53271.SA.D40.3K.PC	40°	990 lm	Phase Cut	Aluminio rallado/Striped aluminum
	K53271.SA.D60.3K	60°	990 lm	No DIM	Aluminio rallado/Striped aluminum
	K53271.SA.D60.3K.PC	60°	990 lm	Phase Cut	Aluminio rallado/Striped aluminum

4000K **10W** 320mA Ø80mm 0,48 Kg

	K53271.W.D40.4K	40°	1010 lm	No DIM	Blanco/White
	K53271.W.D40.4K.PC	40°	1010 lm	Phase Cut	Blanco/White
	K53271.W.D60.4K	60°	1010 lm	No DIM	Blanco/White
	K53271.W.D60.4K.PC	60°	1010 lm	Phase Cut	Blanco/White
	K53271.SA.D40.4K	40°	1010 lm	No DIM	Aluminio rallado/Striped aluminum
	K53271.SA.D40.4K.PC	40°	1010 lm	Phase Cut	Aluminio rallado/Striped aluminum
	K53271.SA.D60.4K	60°	1010 lm	No DIM	Aluminio rallado/Striped aluminum
	K53271.SA.D60.4K.PC	60°	1010 lm	Phase Cut	Aluminio rallado/Striped aluminum

DARA

REF. K50300/1/2/3



UGR
16.2



81 mm

Ø100 mm

7W 350mA Ø86mm 0,34 Kg

- K50300.W.3K 790 lm 3000K Blanco/White
- K50300.W.4K 800 lm 4000K Blanco/White

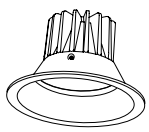

110 mm

Ø160 mm

20W 540mA Ø145mm 0,82 Kg

- K50301.W.3K 1840 lm 3000K Blanco/White
- K50301.W.4K 2010 lm 4000K Blanco/White

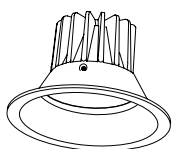

123 mm

Ø190 mm

30W 750mA Ø175mm 1,10 Kg

- K50302.W.3K 2764 lm 3000K Blanco/White
- K50302.W.4K 2836 lm 4000K Blanco/White

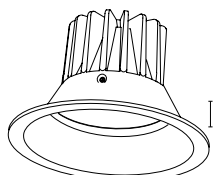

130 mm

Ø230 mm

40W 700mA Ø215mm 1,96 Kg

- K50303.W.3K 3200 lm 3000K Blanco/White
- K50303.W.4K 3320 lm 4000K Blanco/White

DARA ACCESSORIES

REF. KAC50300/1/2/3

REFLECTOR

ESTE PRODUCTO SE SIRVE CON LOS ACCESORIOS MONTADOS
THIS PRODUCT IS SUPPLIED WITH ACCESSORIES ASSEMBLED.



REFLECTOR	REF.
	KAC50300.D15 - KAC50300.D24 - KAC50300.D60
	KAC50301.D15 - KAC50301.D24 - KAC50301.D60
	KAC50302.D24 - KAC50302.D60
	KAC50303.D60



LASSO

REF. K50700/1

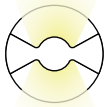
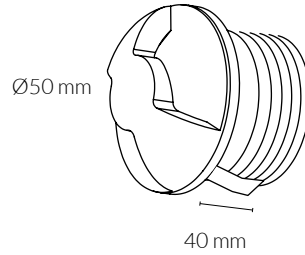
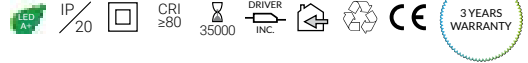

Ø50 mm

	3W	300mA	Ø35mm	0,14 Kg
○ K50700.W	275 lm	3000K	Blanco/White	



Ø50 mm

	3W	300mA	Ø35mm	0,14 Kg
○ K50701.W	275 lm	3000K	Blanco/White	



K50700.W



K50701.W



*Accesorio necesario para techos que no sean de escayola
 ** Accessory needed for ceilings that are different than plasterboard

TUBO PVC - PVC TUBE

Accesorio de fijación
 Fitting accessory

KAC50700 Ø40mm

No incluido
 No included

DETEK DYNAMIC

REF. K53280.DW



IP 20



CRI ≥80

35000

DRIVER INC.



CE



NEW

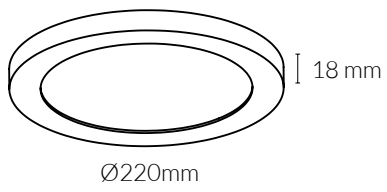

18W 900mA

○ K53280.DW	3K	1715.6 lm	Dynamic White	Detector de presencia Presence detector
	4K	1797 lm		
	5.7K	1900 lm		

SENSOR MICROONDAS
MICROWAVES SENSOR

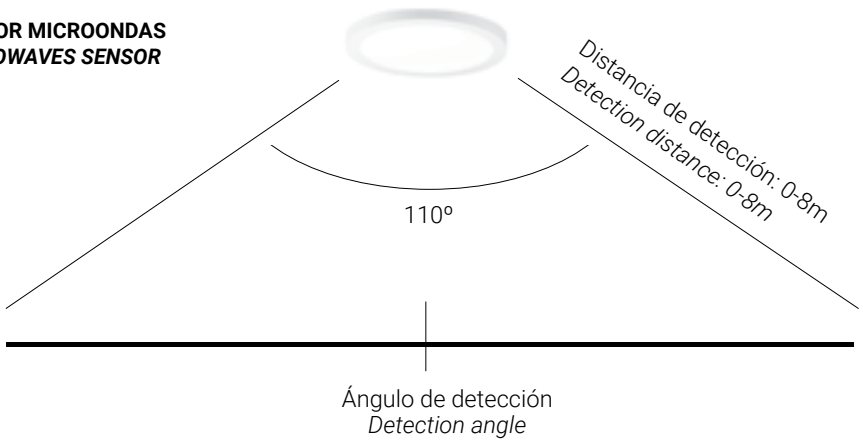

NOON

REF. K50800/1/2



NEW

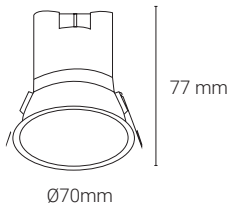

5W 135mA \varnothing 65mm

	K50800.W.3K	512.5 lm	3000K	Blanco/White
	K50800.W.4K	545 lm	4000K	Blanco/White
	K50800.W-G.3K	512.5 lm	3000K	Blanco/White-Oro/Gold
	K50800.W-G.4K	545 lm	4000K	Blanco/White-Oro/Gold

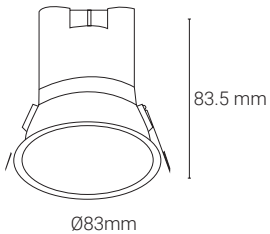

7W 160mA \varnothing 75mm

	K50801.W.3K	632 lm	3000K	Blanco/White
	K50801.W.4K	654 lm	4000K	Blanco/White
	K50801.W-G.3K	632 lm	3000K	Blanco/White-Oro/Gold
	K50801.W-G.4K	654 lm	4000K	Blanco/White-Oro/Gold

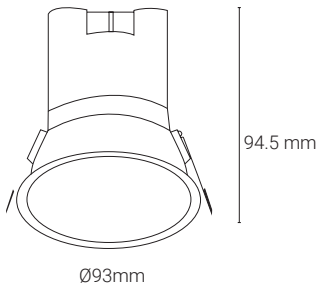

10W 250mA \varnothing 85mm

	K50802.W.3K	869 lm	3000K	Blanco/White
	K50802.W.4K	908 lm	4000K	Blanco/White
	K50802.W-G.3K	869 lm	3000K	Blanco/White-Oro/Gold
	K50802.W-G.4K	908 lm	4000K	Blanco/White-Oro/Gold

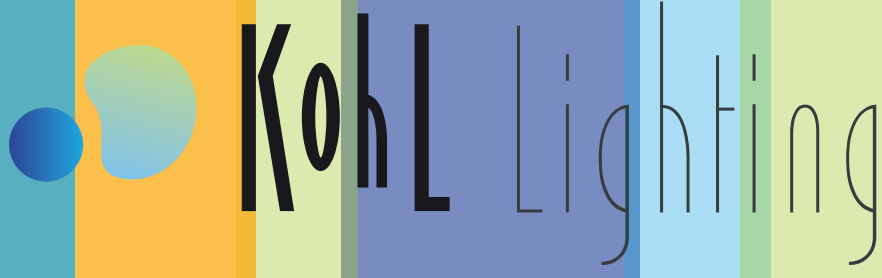

SERENA

REF. K50715/6/7



IP 32



CRI ≥80

15000



DRIVER INC.



3 YEARS WARRANTY

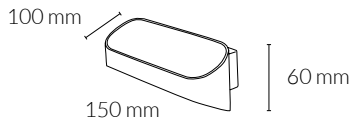

6W 300mA 0,54 Kg

K50715.W.3K 630 lm 3000K Blanco/White

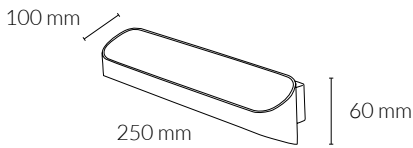

10W 300mA 0,70 Kg

K50716.W.3K 1040 lm 3000K Blanco/White

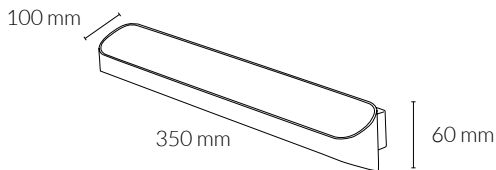

15W 300mA 0,92 Kg

K50717.W.3K 1530 lm 3000K Blanco/White

PANEL LED

INTEGRATED

LED

GU 10

OUTDOOR

LED STRIPS

TECHNICAL

INFORMATION

SUN

REF. K50140



* sin lampara / without lamp
** con lampara / with lamp

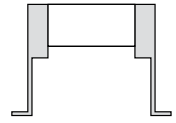
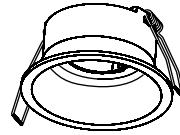

* Ø 75x50 mm
** Ø 75x100 mm

Ø 65 mm 0,16 Kg

-
- K50140.W.GU Blanco/White
 - K50140.BK.GU Negro/Black



DAWN

REF. K50141



* sin lampara / without lamp
** con lampara / with lamp

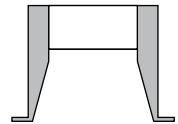
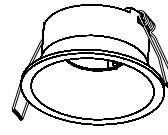

* Ø 75x52 mm
** Ø 75x105 mm

Ø 65 mm 0,20 Kg

-
- K50141.W.GU Blanco/White
 - K50141.BK.GU Negro/Black



MOON

REF. K50110



* sin lampara / without lamp
** con lampara / with lamp

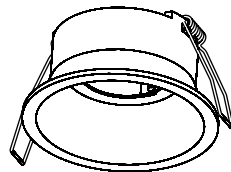

* Ø 85x48 mm
** Ø 85x105 mm

Ø 75 mm 0,16 Kg

- K50110.W.GU Blanco/White
- K50110.BK.GU Negro/Black

VENUS

REF. K50111



* sin lampara / without lamp
** con lampara / with lamp

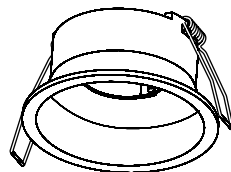

* Ø 92x40 mm
** Ø 92x105 mm

Ø 80 mm 0,18 Kg

- K50111.W.GU Blanco/White
- K50111.BK.GU Negro/Black

OZONE

REF. K50112



* sin lampara / without lamp
** con lampara / with lamp

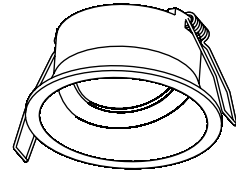

* Ø 90x59 mm
** Ø 90x130 mm

Ø 82 mm 0,16 Kg

- K50112.W.GU Blanco/White
- K50112.BK.GU Negro/Black

DIP IP 65

REF. K50113



* sin lampara / without lamp
** con lampara / with lamp

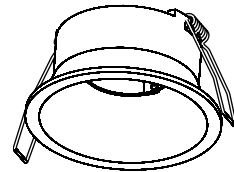

* Ø 86x46 mm
** Ø 86x116 mm

Ø 73 mm 0,24 Kg

- K50113.W.GU Blanco/White
- K50113.BK.GU Negro/Black

DOT

REF. K50130



* sin lampara / without lamp
** con lampara / with lamp

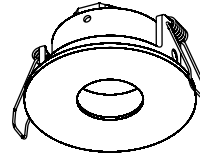

* Ø 80x40 mm
** Ø 80x104 mm

Ø 70 mm 0,12 Kg

- K50130.W.GU Blanco/White
- K50130.BK.GU Negro/Black



DASH

REF. K50131



* sin lampara / without lamp
** con lampara / with lamp

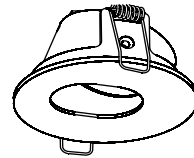

* Ø 80x40 mm
** Ø 80x100 mm

Ø 70 mm 0,12 Kg

- K50131.W.GU Blanco/White
- K50131.BK.GU Negro/Black



DAISY

REF. K50132



* sin lampara / without lamp
** con lampara / with lamp

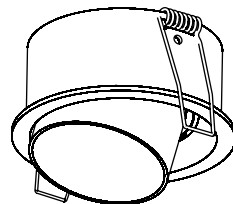

* Ø 83x55 mm
** Ø 83x120 mm

Ø 75 mm 0,16 Kg

- K50132.W.GU Blanco/White
- K50132.BK.GU Negro/Black

FOCUS

REF. K50100



* sin lampara / without lamp
** con lampara / with lamp

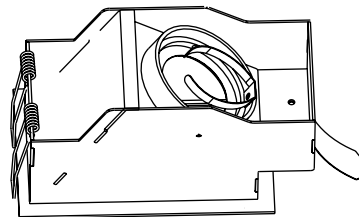

* Ø 130x85x80 mm
** Ø 130x85x120 mm

123x78 mm 0,50 Kg

- K50100.W.GU Blanco/White
- K50100.BK.GU Negro/Black





SAT ROUND

REF. K50126



* sin lampara / without lamp
** con lampara / with lamp

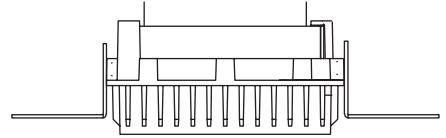

Ø 94x65 mm

Ø 94x110 mm con portalamparas / with LH

Ø 96 mm 0,50 Kg

- K50126.W.GU Blanco/White
- K50126.BK.GU Negro/Black

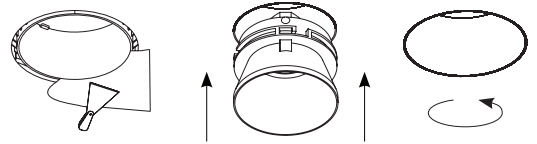

SAT SQUARE

REF. K50125



* sin lampara / without lamp
** con lampara / with lamp

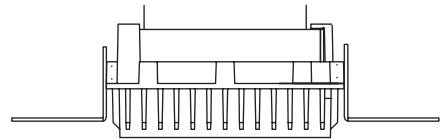

* Ø 73x73x50 mm

73x73x52 mm

** Ø 73x73x120 mm

85x85 mm 0,36 Kg

- K50125.W.GU Blanco/White
- K50125.BK.GU Negro/Black

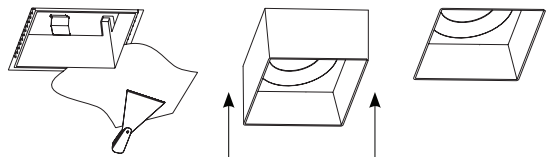

ACCESORIOS GU10

GU10 ACCESORIES

KLB



7W - 120°

○	KLB3K.W	GU10	570 lm	3000K	Blanco/White
○	KLB4K.W	GU10	623 lm	4000K	Blanco/White
●	KLB3K.BK	GU10	570 lm	3000K	Negro/Black
●	KLB4K.BK	GU10	623 lm	4000K	Negro/Black



Ø50x50 mm

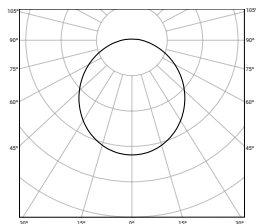

120°

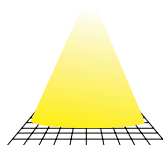

PANEL LED

INTEGRATED

LED

GU10

OUTDOOR

LED STRIPS

TECHNICAL

INFORMATION

BOLETUS

REF. K52400/1

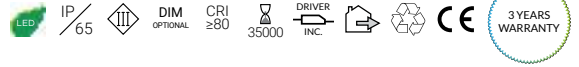

K52400

K52401

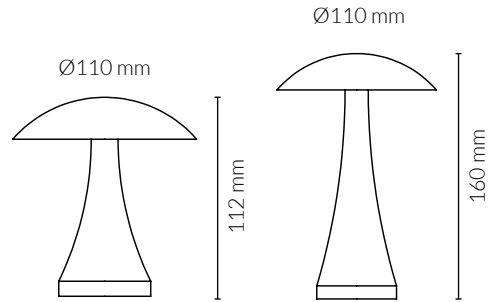

6,3W 500mA



● K52400.BK	85 lm	3000K	0,00 Kg
● K52401.BK	85 lm	3000K	0,66 Kg





TOWER

REF. K52500/1/2

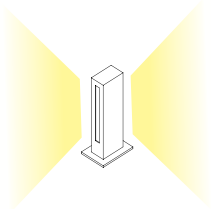
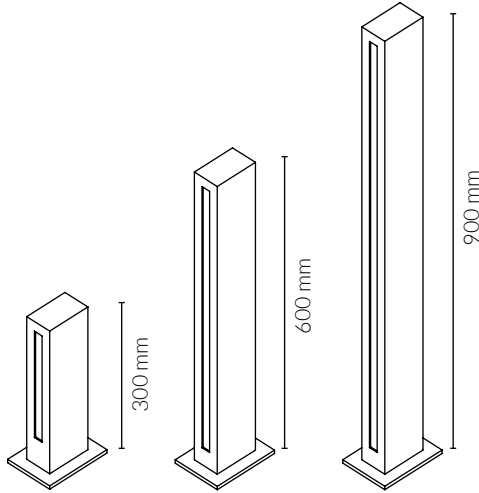

●	K52500.GY	16,7 W	24 V	356 lm	3000K	2,50 Kg
●	K52501.GY	39 W	24 V	806 lm	3000K	3,68 Kg
●	K52502.GY	57 W	24 V	1068 lm	3000K	5,00 Kg





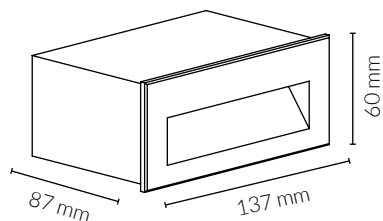

MAILBOX

REF. K52100





 132x55 mm  0,62 Kg

- | | | | | | |
|---|-----------|-------|--------|-------|-------------|
|  | K52100.GY | 3,8 W | 107 lm | 3000K | Gris/Grey |
|  | K52100.BK | 3,8 W | 107 lm | 3000K | Negro/Black |

HUNTER

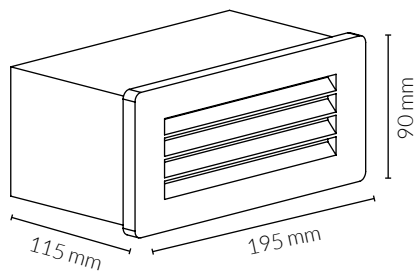
REF. K52200



 190x85 mm  0,98 Kg

- | | | | | | |
|---|-----------|-------|--------|-------|-------------|
|  | K52200.BK | 7,6 W | 114 lm | 3000K | Negro/Black |
|---|-----------|-------|--------|-------|-------------|

HAMMER ROUND

REF. K52300

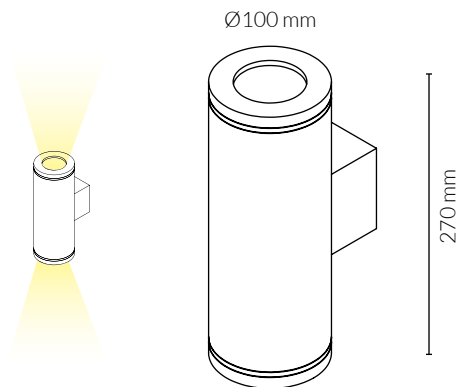

2,38 Kg

●	K52300.GY	15,3+15,3 W	2495 lm	3000K	Gris/Grey
●	K52300.BK	15,3+15,3 W	2495 lm	3000K	Negro/Black

HAMMER SQUARE

REF. K52301

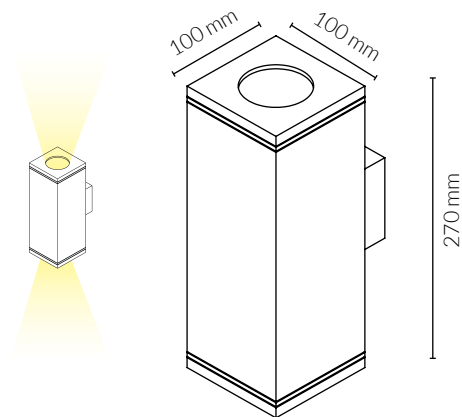



2,86 Kg

●	K52301.GY	15,3+15,3 W	2495 lm	3000K	Gris/Grey
●	K52301.BK	15,3+15,3 W	2495 lm	3000K	Negro/Black

STORM

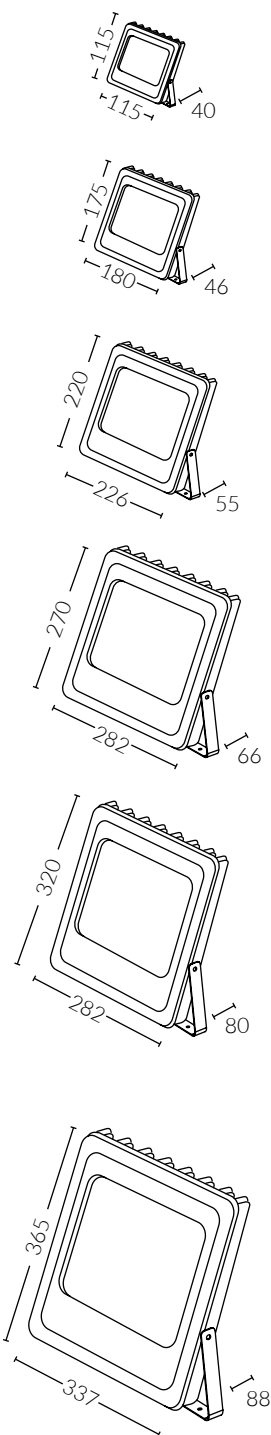
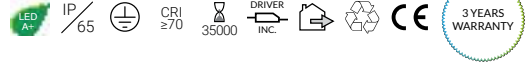
REF. K52600/1/2/3/4/5



10W 300mA  0,98 Kg

●	K52600.BK.3K	3000K	900 lm	Negro/Black	115x115x40 mm
●	K52600.BK.6K	6000K	1000 lm	Negro/Black	115x115x40 mm
○	K52600.W.3K	3000K	900 lm	Blanco/White	115x115x40 mm
○	K52600.W.6K	6000K	1000 lm	Blanco/White	115x115x40 mm

20W 600mA  0,96 Kg

●	K52601.BK.3K	3000K	1800 lm	Negro/Black	180x175x46 mm
●	K52601.BK.6K	6000K	2000 lm	Negro/Black	180x175x46 mm
○	K52601.W.3K	3000K	1800 lm	Blanco/White	180x175x46 mm
○	K52601.W.6K	6000K	2000 lm	Blanco/White	180x175x46 mm

30W 900mA  1,50 Kg

●	K52602.BK.3K	3000K	2700 lm	Negro/Black	226x220x55 mm
●	K52602.BK.6K	6000K	3000 lm	Negro/Black	226x220x55 mm
○	K52602.W.3K	3000K	2700 lm	Blanco/White	226x220x55 mm
○	K52602.W.6K	6000K	3000 lm	Blanco/White	226x220x55 mm

50W 1500mA  2,20 Kg

●	K52603.BK.3K	3000K	4500 lm	Negro/Black	282x270x66 mm
●	K52603.BK.6K	6000K	5000 lm	Negro/Black	282x270x66 mm
○	K52603.W.3K	3000K	4500 lm	Blanco/White	282x270x66 mm
○	K52603.W.6K	6000K	5000 lm	Blanco/White	282x270x66 mm

100W 2x1500mA  3,64 Kg

●	K52604.BK.3K	3000K	9000 lm	Negro/Black	282x320x80 mm
●	K52604.BK.6K	6000K	10000 lm	Negro/Black	282x320x80 mm
○	K52604.W.3K	3000K	9000 lm	Blanco/White	282x320x80 mm
○	K52604.W.6K	6000K	10000 lm	Blanco/White	282x320x80 mm

150W 3x1500mA  5,64 Kg

●	K52605.BK.3K	3000K	13500 lm	Negro/Black	337x365x88 mm
●	K52605.BK.6K	6000K	15000 lm	Negro/Black	337x365x88 mm
○	K52605.W.3K	3000K	13500 lm	Blanco/White	337x365x88 mm
○	K52605.W.6K	6000K	15000 lm	Blanco/White	337x365x88 mm

* Medidas en mm / Measures in mm



PANEL LED

INTEGRATED

LED

GU10

OUTDOOR

LED STRIPS

TECHNICAL

INFORMATION

TIRAS DE LED

LED STRIPS

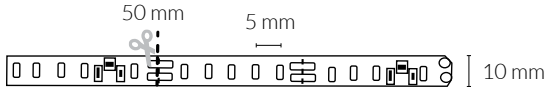

120 LEDs/m	LUMIFLEX CC 28										5m - CRI≥80
	REF	Tensión Voltage	T°. Color	LEDs/m	W/m	lm/m	IP	LED type	EE	Ancho / Wide (mm)	mm
	K55001.CC.27K.20	24V	2700K	120	28,8	2448	IP 20	2835	A+	10	50
	K55001.CC.3K.20	24V	3000K	120	28,8	2592	IP 20	2835	A+	10	50
	K55001.CC.4K.20	24V	4000K	120	28,8	2736	IP 20	2835	A+	10	50
	K55001.CC.55K.20	24V	5500K	120	28,8	2880	IP 20	2835	A+	10	50

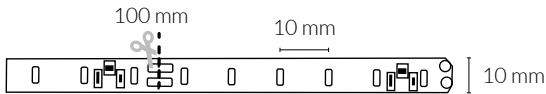

60 LEDs/m	FLEX PRO CC 20										5m - CRI≥90
	REF	Tensión Voltage	T°. Color	LEDs/m	W/m	lm/m	IP	LED type	EE	Ancho / Wide (mm)	mm
	K55002.CC.27K.20	24V	2700K	60	20	1400	IP 20	5630	A	10	100
	K55002.CC.3K.20	24V	3000K	60	20	1500	IP 20	5630	A	10	100
	K55002.CC.4K.20	24V	4000K	60	20	1560	IP 20	5630	A	10	100
	K55002.CC.55K.20	24V	5500K	60	20	1600	IP 20	5630	A	10	100

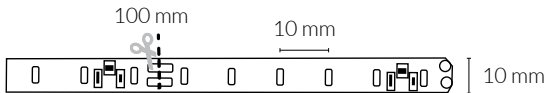

60 LEDs/m	FLEX CV ECO										5m - CRI≥80
	REF	Tensión Voltage	T°. Color	LEDs/m	W/m	lm/m	IP	LED type	EE	Ancho / Wide (mm)	mm
	K55003.CV.27K.20	24V	2700K	60	7,2	561,6	IP 20	3014	A+	10	100
	K55003.CV.3K.20	24V	3000K	60	7,2	612	IP 20	3014	A+	10	100
	K55003.CV.4K.20	24V	4000K	60	7,2	648	IP 20	3014	A+	10	100
	K55003.CV.55K.20	24V	5500K	60	7,2	690	IP 20	3014	A+	10	100

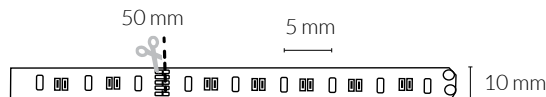

120 LEDs/m	FLEX CV 15										5m - CRI≥80
	REF	Tensión Voltage	T°. Color	LEDs/m	W/m	lm/m	IP	LED type	EE	Ancho / Wide (mm)	mm
	* K55008.CV.27K.20	24V	2700K	120	15	1100	IP 20	3014	A+	10	50
	* K55008.CV.27K.65	24V	2700K	120	15	1100	IP 65	3014	A+	10	50
	* K55008.CV.3K.20	24V	3000K	120	15	1200	IP 20	3014	A+	10	50
	* K55008.CV.3K.65	24V	3000K	120	15	1200	IP 65	3014	A+	10	50
	* K55008.CV.4K.20	24V	4000K	120	15	1400	IP 20	3014	A+	10	50
	* K55008.CV.4K.65	24V	4000K	120	15	1400	IP 65	3014	A+	10	50
	* K55008.CV.55K.20	24V	5500K	120	15	1500	IP 20	3014	A+	10	50
	* K55008.CV.55K.65	24V	5500K	120	15	1500	IP 65	3014	A+	10	50

2700K - 6500K

CAMBIO DE T° DE COLOR
DYNAMIC WHITE



120 LEDs/m	FLEX CC BLANCO DINÁMICO										5m - CRI≥80	
	REF	Tensión Voltage	T°. Color	LEDs/m	W/m	lm/m	IP	LED type	EE	Ancho / Wide (mm)	mm	
	K55004.CC.TW.20	24V	2700K-6500K	120	19,2	561,6	IP 20	3527	A+	10	50	

RGBW

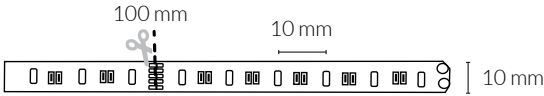

60 LEDs/m	SHOWFLEX CV RGBW										5m - CRI≥80	
	REF	Tensión Voltage	T°. Color	LEDs/m	W/m	lm/m	IP	LED type	EE	Ancho / Wide (mm)	mm	
	K55007.CV.RGBW.20	24V	3000K RGB	60	18	600	IP 20	5050	A	10	100	

RGB

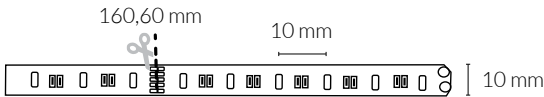

60 LEDs/m	SHOWFLEX CV RGB ECO										5m - CRI≥65	
	REF	Tensión Voltage	T°. Color	LEDs/m	W/m	lm/m	IP	LED type	EE	Ancho / Wide (mm)	mm	
	K55006.CV.RGB.20	24V	RGB	30	7,2	216	IP 20	5050	A	10	166,60	

* Corte a medida (Máx 50m)

* Custom cut (Máx 50m)

PERFILES PARA TIRAS DE LED

LED STRIPS PROFILES

1_ Elige el modelo de perfil / Choose the profile model:

imagenes orientativas de montaje de perfil (no incluidos accesorios)
illustrative images of profile assembly (accessories not included)

KP50001

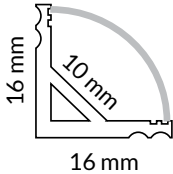

Para tiras LED de IP20.
Gris anodizado.
For IP20 LED strips.
Anodized grey.

KP50002

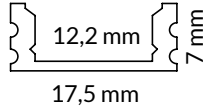

Para tiras LED de IP20.
Gris anodizado.
For IP20 LED strips.
Anodized grey.

KP50003

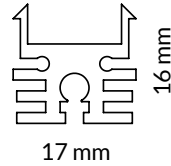

Para tiras LED de IP20.
Gris anodizado.
For IP20 LED strips.
Anodized grey.

KP50004

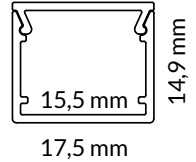

Para tiras LED de IP65.
Disponible en gris anodizado o negro.
For IP65 LED strips.
Available in anodized grey or black.

2_ Monta tu perfil / Set your profile:

- 1 - Combina las medidas de perfil para conseguir una longitud igual o superior a la deseada.
(Si es superior, posteriormente se cortará el perfil sobrante).

Combine profile measures to achieve a length equal to or higher than the desired measure.
(If it is higher, then the excess profile will be cut).

- 2 - Repite el paso anterior eligiendo el tipo de difusor.

Repeats the previous step choosing the optic cover.

- 3 - Elige las tapas laterales.

Choose sides caps.

- 4 - Elige el número de clips.

(Se recomienda un clip por metro, con un mínimo de dos, independientemente de la medida, para tener dos puntos de sujeción).

Choose number of clips.

(One fixing clip per meter is recommended, with a minimum of 2, regardless of length, in order to have two attachment points).

- 5 - Por último, añade el corte si fuera necesario.

Finally, if necessary add cut.

3_ Referencias para montar tu perfil / References to set your profile:

1_ Elige el modelo de perfil / Choose the profile model:

Perfil Profile	Longitud del perfil Profile length	Color Color	
KP50001.01	2 m	Gris anodizado/Anodized grey	
KP50002.01	2 m	Gris anodizado/Anodized grey	
KP50003.01	2 m	Gris anodizado/Anodized grey	
KP50004.GY.01	2 m	Gris anodizado/Anodized grey	
KP50004.BK.01	2 m	Negro/Black	
KP50001.02	3 m	Gris anodizado/Anodized grey	
KP50002.02	3 m	Gris anodizado/Anodized grey	
KP50003.02	3 m	Gris anodizado/Anodized grey	
KP50004.GY.02	3 m	Gris anodizado/Anodized grey	
KP50004.BK.02	3 m	Negro/Black	

2_ Elige el difusor / Choose optic cover:

OPAL			TRANSPARENTE / TRANSPARENT		
Difusor Optic cover	Longitud del perfil Profile length		Difusor Optic cover	Longitud del perfil Profile length	
KD50001.OP.01	2 m		KD50001.OT.01	2 m	
KD50002.OP.01	2 m		KD50002.OT.01	2 m	
KD50003.OP.01	2 m		KD50003.OT.01	2 m	
KD50004.OP.01	2 m		KD50004.OT.01	2 m	
KD50001.OP.02	3 m		KD50001.OT.02	3 m	
KD50002.OP.02	3 m		KD50002.OT.02	3 m	
KD50003.OP.02	3 m		KD50003.OT.02	3 m	
KD50004.OP.02	3 m		KD50004.OT.02	3 m	

3_ Elige tapas / Choose caps:

SIN AGUJERO / WITHOUT HOLE		CON AGUJERO / WITH HOLE	
Tapas / Caps		Tapas / Caps	
KPEC50001 / KPEC50002 / KPEC50003		KPEC50001.H / KPEC50002.H / KPEC50003.H	
KPEC50004		KPEC50004.H	

4_ Clips de sujeción / Fixing clips:

Clips de sujeción / Fixing clips	
KC50001 / KC50002 / KC50003	
KC50004	

5_ Corte / Cut:

Corte / Cut	
KPCUT	

Ejemplo de un perfil KP50001 de 6,5m con difusor opal / Example of 6,5m KP50001 profile with opal optic cover:

(1 KP50001.01 + 2 KP50001.02) + (1 KD50001.OP.01 + 2 KD50001.OP.02) + (1 KPEC50001 + 1 KPEC50001.H) + 7 KC50001 + KPCUT

EQUIPOS PARA TIRAS DE LED

LED STRIPS DRIVERS

	KDV55100.20	ELT	TIRAS LED LED STRIPS	20W	146x46x23 mm	IP20	24V	
	KDV55100.30	VOSSLOH	TIRAS LED LED STRIPS	30W	132x42x32 mm	IP20	24V	
	KDV55100.60	VOSSLOH	TIRAS LED LED STRIPS	60W	182x50x30 mm	IP20	24V	
	KDV55100.75	VOSSLOH	TIRAS LED LED STRIPS	75W	192x45,8x63 mm	IP20	24V	
	KDV55101.120	VOSSLOH	TIRAS LED LED STRIPS	120W	300x40x30 mm	IP20	24V	
	KDV55101.150	TCI	TIRAS LED LED STRIPS	150W	240x60x49 mm	IP20	24V	

* Recomendamos dimensionar la instalación hasta un 90% de la potencia de la fuente
** it is recommended that the system doesn't exceed the total of 90% of the power supply limit*
 ** Recomendamos usar una fuente por cada 10 mt. de tira led
*** It is recommended to use 1 power supply per each 10m of led stripe done*

REGULADORES PARA TIRAS DE LED

LED STRIPS DIMMERS





	<p>REGULADOR TIRA DE LED / DIMMER LED STRIP</p> <p>KDFLEX1 6A/2CH TOUCH LED 4 ZONE 2.4G 144W (12V) 288W (24V) 152x41x28 mm</p>	
--	--	--

ACCESORIOS FLEX BLANCO DINÁMICO

DIMMERS DYNAMIC WHITE FLEX

	<p>CONTROLADOR TEMPERATURA DE COLOR CONTROL COLOR TEMPERATURE</p> <p>KACFLEX1 4 ZONE 2.4G 4A/2CH 96W (12V) 192W (24V) 85x45x23 mm</p>	
	<p>CONTROLADOR TEMPERATURA DE COLOR CONTROL COLOR TEMPERATURE</p> <p>KACFLEX2 4 ZONE 2.4G 6A/4CH 144W (12V) 288W (24V) 152x41x28 mm</p>	

ACCESORIOS RGB RGB ACCESSORIES

	<p>AMPLIFICADOR RGB / RGB AMPLIFIER</p> <p>KACRGB1 DC12V-24V 3 CH 4A/CH 144W (12V) 288W (24V) 105x64x23 mm</p>	
	<p>CONTROLADOR RGB / RGB CONTROL</p> <p>KACRGB2 DC12V-24V 3 CH 4A/CH 144W (12V) 288W (24V) 85x45x23 mm</p>	
	<p>CONTROLADOR RGB / RGB CONTROL</p> <p>KACRGB3 DC12V-24V 3 CH 6A/CH 144W (12V) 288W (24V) 83x79x32 mm</p>	
	<p>CONTROLADOR RGB PARED / RGB WALL CONTROL</p> <p>KACRGB4 DC12V-24V 3 CH 4A/CH 144W (12V) 288W (24V) 86x86x32 mm</p>	
	<p>DECODIFICADOR DMX / DMX LED CONTROL</p> <p>KACRGB5 DC12V-24V 3 CH 4A/CH 144W (12V) 288W (24V) 177x40x32 mm</p>	

ACCESORIOS SHOWFLEX RGBW SHOWFLEX RGBW ACCESSORIES

	<p>CONTROLADOR RGBW / RGBW CONTROL</p> <p>KACRGBW1 DC12V-24V 6A/4CH 288W (12V) 576W (24V) 153x41x29 mm</p>	
---	--	--

PANEL LED

INTEGRATED

LED

GU10

OUTDOOR

LED STRIPS

TECHNICAL

























INFORMATION

MEDIDAS DE CORTE - CUT OUT

K50700	LASSO	Ø35 mm
K50701	LASSO	Ø35 mm
K50600	TINY ROUND	Ø75 mm
K50601	TINY SQUARE	Ø75 mm
K50250	TRIM	Ø75 mm
K50255	TRIM SQUARE	75x75 mm
K50150	LUXO	Ø76 mm
K53270	REBECCA	Ø80 mm
K53271	REBECCA SQUARE	Ø80 mm
K50300	DARA	Ø86 mm
K50310	LIM ROUND	Ø86 mm
K50315	LIM SQUARE	Ø86 mm
K50151	LUXO	Ø90 mm
K53252	MARJAL SQUARE	Ø90 mm
K53262	MARJAL	Ø90 mm
K50405	TINA ROUND	Ø95 mm
K50415	TINA SQUARE	98x98 mm
K50210	DISC SQUARE	100x100 mm
K50200	DISC	Ø108 mm
K53300	LACUS	Ø90 mm
K53301	LACUS	Ø142 mm
K53302	LACUS	Ø190mm
K53100	MIRANDA	Ø109 mm
K53105	MIRANDA SQUARE	109x109 mm
K50400	CIRQUE	Ø110 mm
K50410	CORNER	110x110 mm
K50152	LUXO	Ø113 mm
K50212	DISC SQUARE	120x120 mm
K50251	TRIM	Ø130 mm
K50256	TRIM SQUARE	130x130 mm
K53251	MARJAL SQUARE	Ø135 mm
K53261	MARJAL	Ø135 mm

K50311	LIM ROUND	Ø136 mm
K50316	LIM SQUARE	Ø136 mm
K53305	LACUS SQUARE	Ø90 mm
K53306	LACUS SQUARE	Ø135 mm
K53307	LACUS SQUARE	Ø210 mm
K50800	NOON	Ø62 mm
K50801	NOON	Ø76 mm
K50802	NOON	Ø90 mm
K50301	DARA	Ø145 mm
K50201	DISC	Ø150 mm
K50211	DISC SQUARE	150x150 mm
K50252	TRIM	Ø155 mm
K50257	TRIM SQUARE	155x155 mm
K53101	MIRANDA	Ø159 mm
K53106	MIRANDA SQUARE	159x159 mm
K50401	CIRQUE	Ø170 mm
K50406	TINA ROUND	Ø170 mm
K50411	CORNER	170x170 mm
K50416	TINA SQUARE	170x170 mm
K50302	DARA	Ø175 mm
K50407	TINA ROUND	Ø200 mm
K50258	TRIM SQUARE	200x200 mm
K50312	LIM ROUND	Ø201 mm
K50317	LIM SQUARE	Ø201 mm
K50202	DISC	Ø205 mm
K53102	MIRANDA	Ø214 mm
K53107	MIRANDA SQUARE	214x214 mm
K50303	DARA	Ø215 mm
K50313	LIM ROUND	Ø266 mm
K50318	LIM SQUARE	Ø266 mm
K50203	DISC	Ø280 mm
K50206	DISC	Ø580 mm
K20123	PREMIUM	Ø83 mm

SÍMBOLOS - SIMBOLS

-  **CE** Conforme a las directivas europeas y la norma EN 60598
According to european directives and EN 60598
-  **Depositar los residuos en un centro de recogida autorizado**
Leave waste in an authorized recycling center
-  **Corte rectangular**
Rectangular cut
-  **Corte circular**
Circular cut
-  **Clase I (Clases de protección contra choques eléctricos)**
Class I (Protection classes against electric shocks)
-  **Clase II (Clases de protección contra choques eléctricos)**
Class II (Protection classes against electric shocks)
-  **Clase III (Clases de protección contra choques eléctricos)**
Class III (Protection classes against electric shocks)
-  **Eficiencia energética LED**
LED energy efficiency
-  **Garantía**
Warranty
-  **3000K**
3000K Color temperature
-  **4000K**
4000K Color temperature
-  **6000K**
6000K Color temperature
-  **Portalámparas GU10**
GU10 Lampholder
-  **Nuevo producto. Consultar existencias**
New product. Consult stock
-  **DIM**
OPTIONAL Regulador opcional bajo consulta
Optional dimmer on request
-  **DRIVER**
INC. Equipo incluido
Driver included
-  **DRIVER**
NO INC. Equipo (o transformador) no incluido
Driver (or transformer) not included
-  **Lámpara no incluida**
Lamp not included
-  **IP**
XX Grado de protección contra polvo y humedad
Degree of protection against dust and humidity
-  **Vida útil**
Life time
-  **Grados de basculación**
Tilting degree
-  **Grados de giro**
Rotation degrees
-  **Ángulo de apertura del reflector**
Reflector opening angle
- CRI** Índice de reproducción cromática
Color rendering index
-  **Uso Interior**
Indoor use
-  **Uso exterior**
Outdoor use
- W** **Vatios**
Watts
- MAX W** **Vatios máximos**
Maximum watts
- mA** **Miliamperios**
Milliamps

COLORES - COLORS

Codificación de colores para WINNER y ELITE / Colors code for WINNER & ELITE:

Verde / Green
RAL 6018
.GR

Naranja / Orange
RAL 2004
.OR

Negro / Black
RAL 9005
.BK

Aqua / Aqua
RAL 5021
.AQ

Rojo / Red
RAL 3000
.RE

Gris / Grey
RAL 9006
.GY

Azul / Blue
RAL 5022
.BL

Flamenco / Flamingo
RAL 3018
.FL

Blanco / White
RAL 9003
.W

Oro / Gold
SG 25
.G

Rosa / Pink
RAL 3014
.PI

FOTOMETRÍAS PHOTOMETRICS

WINNER - ELITE - CHESS

REF: K50503 - K50504 - K50505 - K50506 - K50500 - K50501

3000K - 4000K - 6000K

OPAL

3000K

4000K

6000K

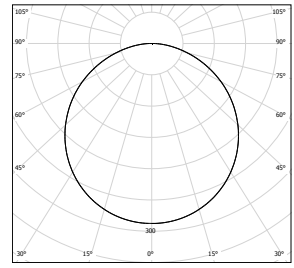
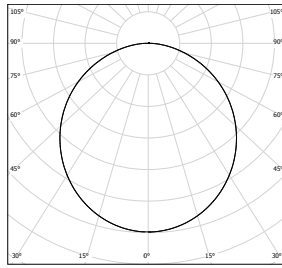
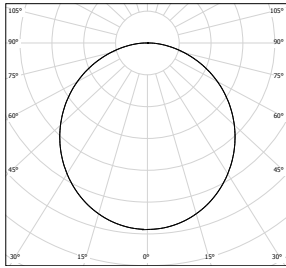

MICROPRISMÁTICO
MICROPRISMATIC

3000K

4000K

6000K

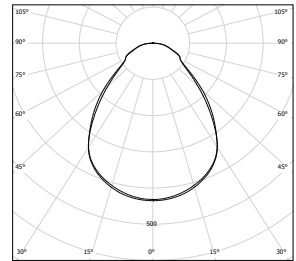
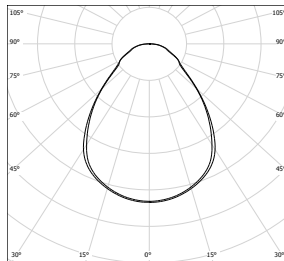
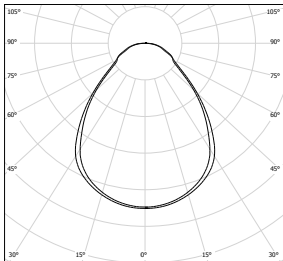

MARJAL - MARJAL SQUARE

REF: K53262 - K553261 - K53260 -
K53252 - K53251 - K53250

3000K - 4000K

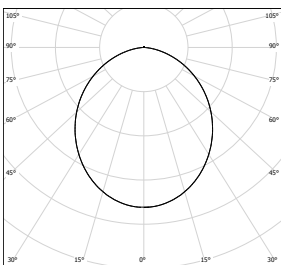

LIM ROUND - LIM SQUARE

REF: K50310 - K50311 - K50312 -
K50313 - K50315 - K50316 - K50317 -
K50318

3000K - 4000K

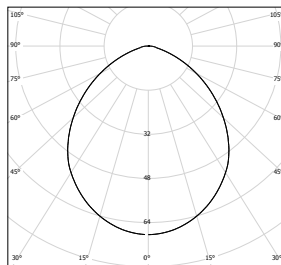

TINA ROUND - TINA SQUARE

REF: K50405 - K50406 - K50415 -
K50416

3000K - 4000K

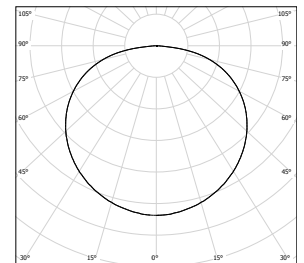

DISC - DISC SURFACE

REF: K50200 - K50201 - K50202 -
K50203 - K50206 - K50220 - K50221
K50222 - K50223 - K50225 - K50226

3000K - 4000K - 6000K

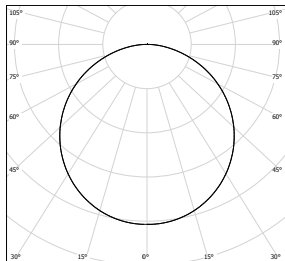

**DISC SQUARE /
DISC SQUARE SURFACE**

REF: K50210 - K50211 - K50212 -
K50230 - K50231 - K50232 - K50233

3000K - 4000K - 6000K

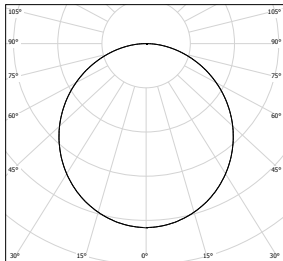

REBECCA - REBECCA SQUARE

REF: K53270 - K53271

3000K - 4000K

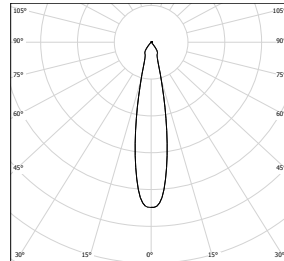

CIRQUE

REF: K50400 - K50401

3000K - 4000K

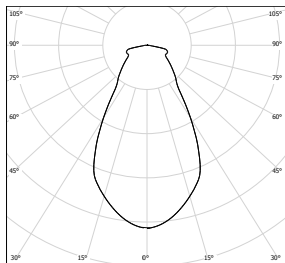

CORNER

REF: K50410 - K50411

3000K - 4000K

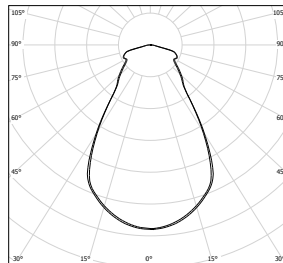

DETEK

REF: K53265 - K53266

3000K - 4000K

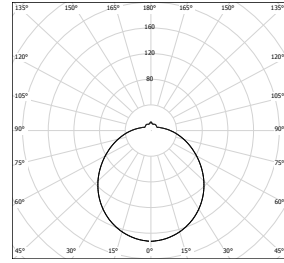

DARA

REF: K50300 - K50301 - K50302 -
K50303

3000K - 4000K

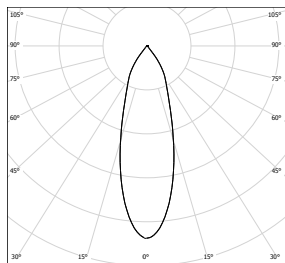

Consulte todas las fotometrias en nuestra web www.kohl_lighting.com
Consult all photometries in our website www.kohl_lighting.com

GRADO DE PROTECCIÓN IP

IP DEGREE OF PROTECTION

Según la Norma IEC 60529, el grado de protección IP especifica los diferentes niveles de protección aportados por los contenedores que resguardan los componentes de los equipos eléctricos o electrónicos. Cuanto mayor es el grado de protección IP, más protegido está el equipamiento.

Un grado de protección IP XY indica lo siguiente:

As IEC 60529 standard says, the IP protection degree specifies the different protection levels provided by the containers that protect the components in electrical or electronic equipment. The greater the IP protection degree, the more protected the equipment is. An IP XY protection degree indicates the following:

X: Describe el nivel de protección contra polvo y otras partículas / *Describes the level of protection against dust and other particles*

X	Grado de protección contra polvo / Protection grade against dust
0	Sin protección / Without protection
1	Protegida contra sólidos de más de 50 mm / Protected against solids bigger than 50 mm
2	Protegida contra sólidos de más de 12 mm / Protected against solids bigger than 12 mm
3	Protegida contra sólidos de más de 2,5 mm / Protected against solids bigger than 2,5 mm
4	Protegida contra sólidos de más de 1 mm / Protected against solids bigger than 1 mm
5	Protegida contra la entrada de polvo / Protection against the entrance of dust
6	Totalmente protegida del polvo / Full protected against dust

Y: Describe el nivel de protección contra líquidos / *Describes the level against liquids*

Y	Grado de protección contra líquidos / Protection grade against liquids
0	Sin protección / Without protection
1	Protegida contra la caída vertical de gotas de agua / Protected against drops of water falling vertically
2	Protegida contra la caída de gotas de agua con una inclinación máxima de 15° <i>Protected against drops of water falling at a maximum inclination of 15°</i>
3	Protegida contra agua pulverizada / Protected against sprayed water
4	Protegida contra las proyecciones de agua / Protected against splashes of water
5	Protegida contra los chorros de agua / Protected against jets of water
6	Protegida contra mar gruesa / Protected against heavy tide
7	Protegida contra los efectos de la inmersión / Protected against plunging effects
8	Protegida contra la inmersión prolongada / Protected against long immersion

*Los procedimientos especializados de limpieza no están cubiertos por los grados de protección IP. Se recomienda que los fabricantes suministren, si es necesario, una adecuada información en lo referente a los procedimientos de limpieza. Esto está de acuerdo con las recomendaciones contenidas en la Norma IEC 60529 para los procedimientos de limpieza especiales.

**Specialized cleaning procedures are not covered by IP ratings. It is recommended that manufacturers provide, if necessary, adequate information regarding cleaning procedures. This is in accordance with the recommendations contained in IEC 60529 for special cleaning procedures.*

CLASES DE PROTECCIÓN CONTRA CHOQUES ELÉCTRICOS

PROTECTION CLASSES AGAINST ELECTRIC SHOCKS

According to the type of protection they offer against electric shocks, light fittings are classified as: Class I, Class II and Class III.

Las luminarias se clasifican en función de su tipo de protección contra los choques eléctricos, en: Clase I, Clase II y Clase III.



Class I: Luminarias en la que la protección contra los choques eléctricos no recae exclusivamente sobre el aislamiento principal, sino que comprende una medida de seguridad suplementaria bajo la forma de medios de conexión de las partes conductoras accesibles con un conductor de protección puesto a tierra, formando parte del cableado fijo de la instalación, de tal manera que las partes conductoras accesibles no puedan llegar a ser peligrosas, en caso de defecto del aislamiento principal. La toma tierra es de color amarillo y verde en la mayoría de los países, y verde en los Estados Unidos, Canadá y Japón.

Class I: Light fittings in which protection against electric shocks does not depend solely on the mains insulation, but instead contain an extra safety measure in the form of a circuit from the accessible conductive parts with an grounded protective conductor forming part of the installation's fixed wiring, so that the accessible conductive parts do not become dangerous should there be a defect in the mains insulation. Ground conductor is coloured green&yellow in most countries, and just green in the U.S., Canada and Japan.



Class II: Dispositivo de Clase II o aparato con doble aislamiento eléctrico es uno que ha sido diseñado de tal forma que no requiere una toma a tierra de seguridad eléctrica. El requisito básico es que un fallo simple no puede dar lugar a tensiones peligrosas que puedan causar una descarga eléctrica. Esto se consigue mediante dos capas de material aislante rodeando las partes con tensiones peligrosas o utilizando un aislamiento reforzado.

Class II: A Class II or double insulated electrical appliance is one which has been designed in such a way that it does not require a safety connection to electrical ground. The basic requirement is that no single failure can result in dangerous voltage becoming exposed so that it might cause an electric shock and that this is achieved without relying on an earthed metal casing. This is achieved having two layers of insulating material surrounding live parts or by using reinforced insulation.



Class III: Un aparato de Clase III está diseñado para ser alimentado por una fuente de alimentación SELV (por sus siglas en inglés: "Separated or Safety Extra-Low Voltage"). La tensión de una fuente de SELV es lo suficientemente baja para que, en condiciones normales, una persona puede entrar en contacto con ella sin correr el riesgo de descarga eléctrica. Por tanto, no es necesario incorporar la seguridad que llevan los aparatos de Clase I y Clase II. Para el cumplimiento de los dispositivos médicos la Clase III no se considera suficiente para su protección.

Class III: A Class III appliance is designed to be supplied from a separated/safety extra-low voltage (SELV) power source. The voltage from a SELV supply is low enough that under normal conditions a person can safely come into contact with it without risk of electrical shock. The extra safety features built into Class I and Class II appliances are therefore not required. For medical devices compliance with Class III is not considered sufficient protection.

CONDICIONES DE GARANTÍA

WARRANTY CONDITIONS

Kohl Lighting S.L. garantiza sus luminarias, así como los equipos que distribuye.

1- Los productos de Kohl Lighting S.L. están garantizados contra cualquier defecto de fabricación (componentes y mano de obra) durante un periodo de tres años a partir de la fecha de compra, a menos que se indique otra fecha.

2- En razón de esta garantía, sólo incumbe a Kohl Lighting S.L. la obligación de reparar o reemplazar el producto o la pieza reconocidos como defectuosos y devueltos a Kohl Lighting S.L.

3- Las reclamaciones por posibles incidencias como que el producto se entregue deteriorado, averiado, equivocado, o por cualquier otra causa susceptible de reclamación, se tratarán de la siguiente forma:

- Siempre deberá devolverse adjuntando copia de la factura de compra.

- El comprador podrá solicitar la devolución del importe en el plazo de 7 días posteriores a la recepción del pedido. Si bien deberá satisfacer gastos directos de devolución y en su caso, indemnizar los desperfectos del producto (según ley del 15/1/96 número 7/1996 del comercio minorista).

- Si por el contrario desea la sustitución del producto, el cliente deberá remitir el mismo a Kohl Lighting S.L. en el mismo plazo de 7 días, y una vez recibido, se enviará un producto en perfecto estado.

4- Toda devolución de producto invocando la garantía debe ser previamente aceptada por Kohl Lighting S.L. En todas las devoluciones el cliente se pondrá en contacto telefónico y propondrá un número de avería y/o devolución. Dicho producto defectuoso se devolverá con el precinto de garantía intacto, en su embalaje original con sus equipos, cables y demás elementos que tuviesen en el momento de su compra y con su fallo correspondiente. Deberá ir acompañado de ese número de devolución previamente dado.

GARANTÍA DE SATISFACCIÓN:

Se podrá renunciar a la compra en un plazo máximo de 7 días, a contar desde el día de recepción de la mercancía, y la compra deberá retornarse con su embalaje original completo y en perfecto estado. Para cualquier controversia en la interpretación o ejecución que se suscite, las partes se someten, con renuncia del fuero que pueda corresponderles, a los juzgados y tribunales de la ciudad del comprador. Las devoluciones deberán ser enviadas junto con el original de la hoja de devolución, debidamente cumplimentado, que acompaña al albarán.

Las devoluciones deben remitirse a la siguiente dirección: **Partida Madrigueres Sud, 63A Naves 1-4, 03700 Dénia, (Alicante)**

Respecto a devoluciones de mercancía que no se encuentre defectuosa, se deben tener en cuenta las siguientes particularidades:

- En general no se aceptarán devoluciones de aquellos productos cuya compra se haya realizado bajo pedido confirmado y productos que hayan quedado descatalogados.

- La devolución del importe se efectuará mediante abono. Para proceder al abono de un producto deberá llegar en perfectas condiciones y con todos sus accesorios.

- Los abonos sólo procederán una vez la mercancía sea aceptada por nuestro servicio de Asistencia Técnica.

- En las devoluciones a criterio del cliente se abonará el importe de la compra exceptuando los gastos de envío.

- Kohl Lighting S.L. se reserva el derecho abonar a una cantidad inferior en caso de que el material no llegue en perfectas condiciones o con todos sus accesorios.

5- El plazo de garantía comienza a partir de la fecha de emisión de factura, no pudiendo ser ampliado en ningún caso por sustitución de un componente en una reparación o cambio.

6- La pérdida o deterioro durante el transporte por agencia no es responsabilidad de Kohl Lighting S.L.

Existen fabricantes y marcas que ofrecen su garantía directamente. Los teléfonos de contacto y procedimiento de asistencia serían facilitados en caso de necesidad.

CLAÚSULAS DE ANULACIÓN DE LA GARANTÍA:

- Incorrecta utilización, manipulación o mantenimiento por parte del Cliente de un equipo, luminaria o componente.

- Incorrecta reparación, modificación o ampliación por parte del Cliente de una luminaria o un equipo.

- Deterioro, eliminación u ocultación, por parte del Cliente, de la etiqueta identificativa de Kohl Lighting S.L.

Es decir, no se aceptará ningún material dañado, sin embalaje o con muestras evidentes de una manipulación incorrecta.

LA GARANTÍA NO CUBRE:

Quedan excluidos de toda garantía los defectos y deterioros producidos por hechos externos, accidentes, principalmente accidentes eléctricos, por desgaste y por utilización no conforme a las instrucciones.

Kohl Lighting S.L. no se responsabiliza de los errores o roturas producidas en el envío del producto. En caso de defecto o rotura no asumida por parte del departamento de atención técnica, se procederá a la devolución del producto a portes debidos.

Estas condiciones de garantía no afectan a los derechos estatutarios del consumidor amparados por su legislación vigente nacional aplicable.

HOJAS DE RECLAMACIÓN:

De acuerdo con el art. 1 del RD 5/1997 14 Enero, existen hojas de reclamación a disposición de nuestros clientes en el domicilio social de la empresa.

Kohl Lighting S.L. guarantees its fixtures and distributed gears.

1- Kohl Lighting S.L. products are guaranteed against defects in workmanship (parts and labor) for a period of three years from the date of purchase, unless other date indicated.

2- Due to this guarantee, the incumbent of Kohl Lighting S.L. is the obligation to repair or replace the product or part recognized as defective and returned to Kohl Lighting S.L..

3- Claims for incidents as the product is delivered damaged, broken, wrong, or any other cause shall be treated as follows:

- There will always be returned enclosing a copy of the invoice.
- The buyer may request a refund within 7 days of the receipt of the order. While it must satisfy direct cost of returning and where appropriate, compensate the damage to the product (Spanish Act of 15/1/96 number 7/1996 retail).
- If instead the replacement of the product is requested, the customer must submit them to Kohl Lighting S.L. within 7 days, and once received, the product will be sent in perfect conditions.

4- Any return of product invoking this guarantee must be previously accepted by Kohl, all returns to be governed by the following points:

- The customer will call the customer service of Kohl Lighting S.L., which will provide a number of breakdown and / or return.
- The defective product will be returned with the warranty seal intact, in their original packaging with their ballasts, cables and other items they had at the time of the purchase and corresponding failure. It must be accompanied by the return number.

SATISFACTION GUARANTEE:

The Customer may return the merchandise within a period of 7 days starting from the day of receipt, and it must be accompanied by the original packaging and in perfect condition. Any dispute regarding the interpretation or execution that may arise, the parties hereby waiving of jurisdiction that may apply, the courts of the city of the buyer. The returns should be sent with the original return sheet, duly completed, accompanying by the delivery note.

Returns must be sent to the following address: **Partida Madrigueres Sud, 63A Naves 1-4, 03700 Dénia, (Alicante)**

Regarding returns of merchandise that is not defective, you should consider the following features:

- In general, no returns of products whose purchase was made on confirmed order and products that have been discontinued will be accepted.
- The refund will be by a credit note. To proceed to the payment the product should arrive in perfect condition and with all accessories.
- The payments will only proceed once merchandise is accepted by our Technical Support Department. For returns which are up to the customer the amount of the purchase excluding shipping costs will be paid.
- Kohl Lighting S.L. reserves the right to pay a lower amount if the material does not arrive in perfect condition and with all accessories.

5- The warranty period starts from the date of invoice Kohl Lighting S.L. and cannot be extended in any way by replacing a component in a repair or exchange.

6- Loss or damage during the transport is not responsibility of Kohl Lighting S.L.

There are manufacturers and brands that offer their warranty directly. Contact phone number and assistance would be provided if necessary.

CLAUSES OF CANCELLATION OF WARRANTY:

- Improper use, handling or maintenance by the Customer of a gear, lighting fixture or a component.
 - Improper repair, modification or extension by the Customer of a lighting fixture or a gear.
 - Impairment, disposal or concealment by the Customer of the identification label of Kohl Lighting S.L.
- This meaning that no returns without original packaging or with obvious signs of improper manipulation will be accepted.

NOT COVERED:

Excluded from any warranty are the defects and damage caused by external events, accidents, electrical accidents mainly due to wear out and use not in accordance with the instructions of Kohl.

Kohl Lighting S.L. is not responsible for errors or breakages during the shipping of the product. In case of returns not assumed by our Technical Support Department, they shall be sent back by due freight.

These warranty conditions do not affect consumer's statutory rights protected by national legislation applicable.

LEAVES OF CLAIM:

According to Spanish art. 1 RD 5/1997 14, there are complaint forms available to our Customers at the registered office of the company.



Kohl Lighting S.L. se reserva el derecho de reproducción total o parcial de este catálogo como propietario del Copyright.

Todos los datos, croquis e imágenes están actualizados el día de la impresión, sin embargo, debido al continuo desarrollo y mejora de los productos, Kohl Lighting se reserva el derecho de modificarlos sin previo aviso.

Kohl Lighting S.L. reserves the right to reproduce total or partially this catalogue as Copyright owner. All data, sketches and pictures are up to date at the day of print, nevertheless, due to continuous product development and improvement, Kohl Lighting reserves the right to alter them without prior notice.

Kohl Lighting

Copyright © 2019

Fecha de impresión / Print date

Marzo / March 2019

Director de arte / Art Director

Bernardo Palomares

Diseño y maquetación / Design and layout

Equipo BPM